

**EARLY  
LOADING TOOLS  
and  
BULLET MOLDS**

**R.H. CHAMBERLAIN**



**EARLY  
LOADING TOOLS  
and  
BULLET MOLDS**

**R.H. CHAMBERLAIN**

Photos by Jeff Edwards

Copyright 1988  
Pioneer Press  
Union City, TN 38261  
ISBN: 0-913150-62-2

## *Acknowledgments*

Thanks are due to a great many people who assisted in this effort. In most cases this will be noted in the text or captions. In particular I wish to thank Charles Suydam for his editing of the manuscript.

Others who have given particular aid or encouragement are the "Big Nine" collectors' group and its late patriarch, George Lower.

Special thanks are due my patient and understanding wife for typing the manuscript and for not saying what she must sometimes think about this peculiar hobby.

Dedicated to the memory of Henry Gier, who early recognized and appreciated loading accessories as a worthwhile collecting interest.

## CONTENTS

INTRODUCTION . . . . .	1
I HANDLOADING CARTRIDGES - AN OVERVIEW . . . . .	4
II WINCHESTER . . . . .	8
III REMINGTON, U.M.C. AND B.G.I. . . . .	19
IV MARLIN AND BALLARD . . . . .	25
V MAYNARD AND STEVENS . . . . .	30
VI SHARPS . . . . .	36
VII SMITH AND WESSON . . . . .	39
VIII IDEAL . . . . .	42
IX MISCELLANEOUS TOOLS . . . . .	55
X MISCELLANEOUS MOLDS . . . . .	67
 PATENTS . . . . .	 71

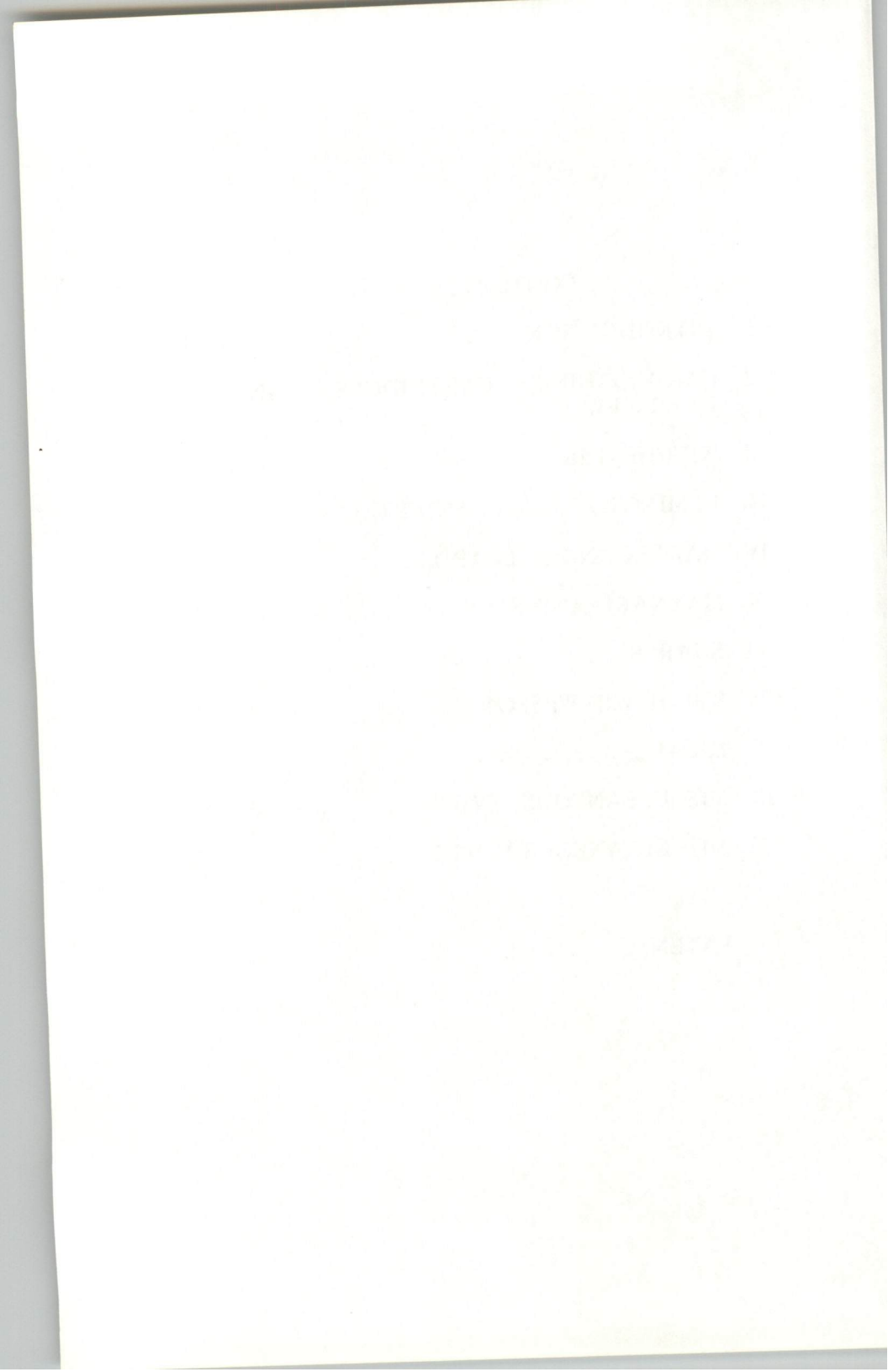



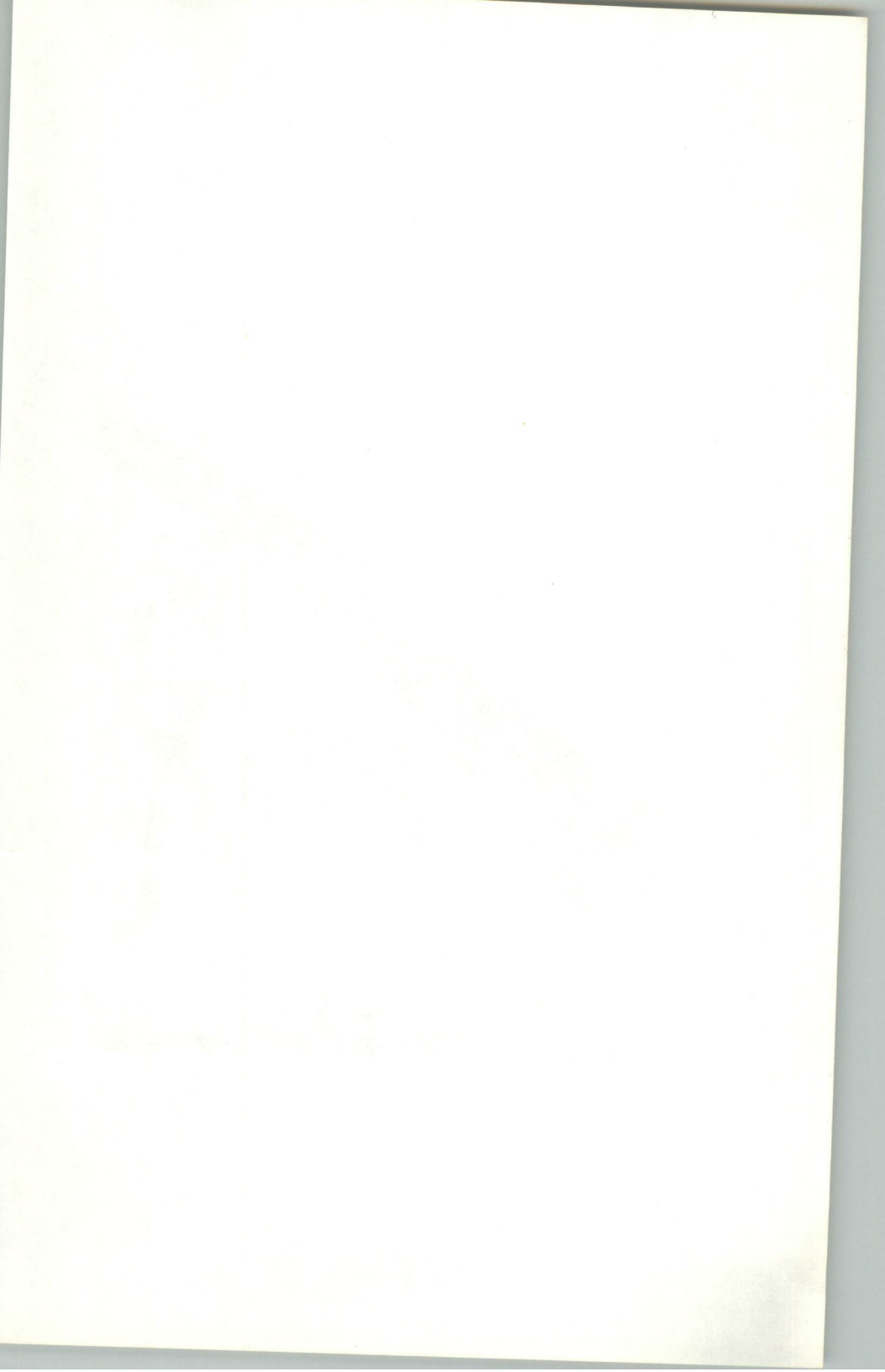



## INTRODUCTION

In recent years much material has been published on the subject of antique firearms. Collectors are becoming increasingly aware of the satisfaction of knowing about their arms. We seek out their production periods, their catalog designations, their place in history, and other pertinent facts. One of the factors which has brought this about is the ever-increasing number of collectors drawing on a supply of arms which cannot appreciably increase. This, coupled with increased prices, has caused collectors to build smaller collections but to devote more attention to each individual piece. Interest has carried over to related items - - witness the increased attention given to such things as powder horns, flasks, and cartridges. There is as yet, however, no single source of information on the various loading tools and molds manufactured in the past. It was to fill that need that this book was undertaken.

The writer's interest in old loading tools began almost twenty years ago. He could not resist stopping at a roadside secondhand shop of the kind often called a trading post. While browsing about he was offered a "leather punch" for the modest price of ten cents. After a reasonably thorough cleaning at home it was found to be an Ideal No. 3 tool for the scarce .22-10 Maynard centerfire cartridge. Some time later interest in these items was strengthened by visits with Henry Gier, to whose memory this book is dedicated. Indeed, our last visit involved plans to take photographs of some of the scarce loading tools he had acquired over the years incidental to his gun collecting. After his death I was able to obtain many of these items; and they are shown herein.

This volume was written in the hope that it will be of value to people in several categories: First there are the gun collectors who may be interested in knowing what loading accessories were used with their various arms, and who may wish to assemble a collection of these items to accompany their principal collection. Such a trend is noticeable at gun shows, where, increasingly, displays include loading tools along with cartridges and other accessories.

Dealers in used or antique arms, too, may find this volume useful, particularly in properly identifying loading tools and molds which they acquire with collections of guns. Such identification serves both the collector and the dealer. Reflecting on this, one wonders how many of the less-recognizable loading items, such as one-piece ball

seaters have been cast aside over the years as collections change hands, simply for lack of knowing that they pertain to firearms.

Interest in firing early or obsolete guns continues and the person interested in pursuing this activity may find here information of value to him, such as how to operate the various early tools.

Finally, this volume was assembled as an aid and encouragement to the increasing number of collectors specializing in loading tools and molds. Although not numerous at present, their ranks seem certain to grow, just as we have seen in the case of powder flask and cartridge collectors.

In deciding what items should be included here it was not considered practical to establish any particular delimiting dates. Some items, such as the Modern Bond and Newton tools, are of relatively modern manufacture but were included because of their uniqueness and place in loading tool development. The other end of the span is more distinct. It begins with the development of metallic cartridges. While muzzle loader accessories are interesting in their own right they have been described in the writing of Ned Roberts and others.

Researching the material for this book has been rewarding and intriguing, although frustrating at times. Relatively little has been written specifically dealing with the subject. In articles in the Gun Digest and The Gun Report the writer has explored it briefly. Grant's Single Shot Rifles and Williams' book on Winchesters have useful identifying information as do other current volumes. Gould's Modern American Rifles, first published in 1892 and republished by Thomas Samworth, has an entire chapter on the subject of loading tools of that time. Much useful material has come from early catalogs, usually reprints, and directly from the tools and molds, particularly when still in their factory boxes. One of the difficulties encountered is that while companies, almost without exception, marked their guns, this was not always the case with loading accessories. Furthermore, a concern such as the Bridgeport Gun Implement Company turned out tools and molds for others as well as under their own label.

Numerous sources have been consulted in the preparation of this volume. Despite this effort there will almost

certainly be errors. Furthermore, some items clearly within the scope of this study will have been overlooked or at least not be illustrated. So no claim is made for completeness. But as with so many research ventures, a time comes when one must "wrap it up" or else consign himself to a lifetime pursuit of every bit of elusive and often insignificant material with little prospect of ultimate completeness anyway.

It is hoped that the reader, whatever his purpose, will find something of value and interest in this volume. Certainly its preparation has been a stimulating and satisfying experience.

# HANDLOADING CARTRIDGES --

## An Overview

Wars almost always stimulate arms development. The Civil War certainly was an example of this. With both a shortage of arms and the fact that the war was fought largely by militia units which sought their own weapons, there was a strong demand for all kinds of firearms. The result was a great profusion of arms. And, although muzzle loading rifles were the standard, the great diversity of weapons was in breech loaders firing fixed or semi-fixed cartridges. There were a few breech loaders before the war, notably the Sharps and Maynard, but it was the war that gave the great impetus to firearms development and with it the development of suitable ammunition.

Most of the Civil War breech loaders fired rimfire cartridges or some kind of combustible or otherwise non-reloadable ammunition. Of the few that could be reloaded, the Sharps, Burnside, and Maynard are discussed in their respective sections.

The earliest tools were quite primitive compared to some of the sophisticated ones that were to follow. About all that was needed was a bullet mold and some way to seat the bullet in the case since the primer was not a part of the cartridge at first.

With the advent of the fully self-contained cartridge the operations of removing the old primer and seating a new one had to be accomplished. The Berdan primers had to be extracted by some sort of chisel which was forced into the spent primer and then used to pry it out. Later came the Winchester type primer as used on modern American centerfire cartridges. It could be forced out by a rod or pin within the case since the flash hole was located in the center of the primer pocket.

Although there was considerable latitude in bullet dimensions at first, the need to size bullets to correct diameter became apparent, particularly if accurate shooting was desired.

In general, the earliest cartridges developed used outside lubricated bullets which, after loading dry, could be dipped in lubricant. They were like the bullets of our modern .22 rimfire cartridges in this respect and also in having a

reduced diameter "heel" to fit inside the case so that both the bullet and the case were of the same outside diameter.

Later came bullets with grooves to hold the lubricant which were covered by the case when loaded. Modern revolver bullets such as the .38 Special are of this type.

About this same time the paper patched bullet made its appearance though the idea had seen limited use in muzzle loading rifles. Thin paper was wrapped, usually twice, around the bullet. In firing, only the paper actually touched the bore thus eliminating leading. A wad of lubricant was often used behind it to reduce friction. A group of early factory bullets is shown in (A).

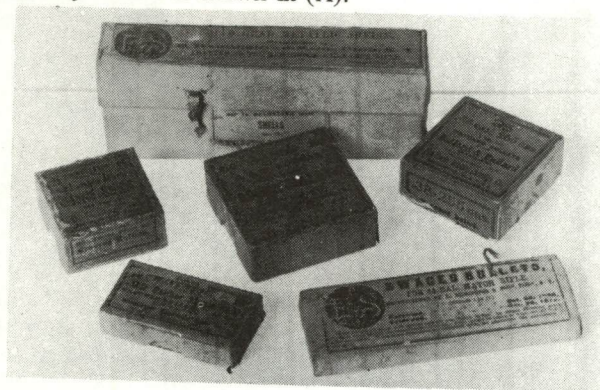

A

There were several reasons for the popularity of hand loading. The most obvious was economy. The most expensive part of a cartridge was the case. By reusing it, as well as by saving on the other costs of factory ammunition, a considerable economy was possible. There were other advantages too. With the dozens of different calibers of arms, finding a supply of ammunition, especially on the frontier or in small communities could be difficult. But lead, powder, and primers were available almost anywhere so the man with a reloading outfit could be assured of ammunition. Still another advantage of reloading was that the charge and bullet weight could be varied to produce loads for target, game, or gallery practice.

In an effort to get the greatest possible case life, "everlasting" shells were developed. These extra heavy cases were turned rather than drawn and some were nickel plated. They were of two types. One kind had the same dimensions as regular cases. The extra metal was in the head and sides of the case but the mouth was of the usual

thickness. Several popular calibers of the time were available in this form. The other type had a thick mouth and could only be used in special chambers. Everlasting cases were only sold empty. Less sturdy but still very durable cases were those marked "S H" standing for solid head. These were drawn cases but the solid head provided a primer pocket that would remain tight.

Until almost the turn of the century only black powder was available. It was produced in several granulations and many different brands but ballistically it was all quite similar. The simplest measuring devices were the powder scoops, an assortment of which are shown in (B). All are for a fixed

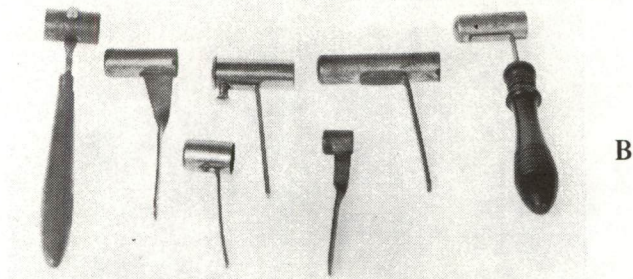

charge except the middle one which is an adjustable Laflin and Rand charger graduated to the 1/16 dram for use with early smokeless powders. A few early canisters list recommended charges in this form but the practice soon gave way to weight designated in grains. Early powder cans were often colorful and interesting in their own right. Those shown in (C) include both black and bulk smokeless.



The latter could be measured as if it were black powder and was available for rifles and pistols as well as shotguns.

Later, when dense powders came into use, they presented



new dangers to the reloader. Prior to this, a case full of any black or bulk smokeless would not produce really excessive pressures, but loading dense powder volume-for-volume with black powder produced ruined guns and injured shooters and for a while hand loading, particularly with smokeless powders, fell into disfavor. However, as shooters came to understand the characteristics and versatility of dense powders, hand loading again became popular.

Two developments during the early days of smokeless powder were designed to combine the clean shooting of the former with the low pressure and accuracy of black powder. One of these was duplex loading, in which a small charge of smokeless is dropped on top of the primer followed by a charge of black powder sufficient to fill the case to regular capacity. This was especially favored by target shooters, a few even using triplex loading with two different granulations of black powder on top of the smokeless priming charge.

The other development was semi-smokeless powder. It could be loaded in the same charges that black powder was, using the same bulk measures. Some factory loaded cartridges employed this kind of powder. For loading data, early shooters could look to the instructions accompanying the loading outfit or the special labels often found on cartridge boxes. While some of the latter specify only the primer to be used others are quite detailed as to bullet alloy, brand of powder, and other details. The appearance of the Ideal Handbooks in the latter part of the 19th century was a great boon to handloaders, particularly those who liked to experiment.

Although this overview is quite brief it will serve as background for the chapters that follow in which more details will be presented as specific tools and molds are considered.

## WINCHESTER

Of all the loading tools produced by arms manufacturers, Winchester tools are the most numerous. Indeed, it appears that Winchester and Ideal together account for more than 90% of the old loading tools and molds found today. Three factors which undoubtedly contribute to the great number of Winchester items are: they were produced over a considerable period of time, they were made for many calibers besides those used in Winchester arms, and Winchester dominated the sporting rifle industry, thus providing its own customers for its tools and molds. Great in numbers, they are also great in variety, and therein lies their special interest to collectors.

The first Winchester rifle, the Model 1866, fired the .44 Henry cartridge. Since it was a rimfire, there was no need or purpose in developing a loading tool. However, with the advent of the Model 1873 and its .44-40 center fire cartridge the opportunity to devise reloading implements was at hand. The result was the first of the Winchester tools. This exceedingly scarce tool is shown in (A). It was

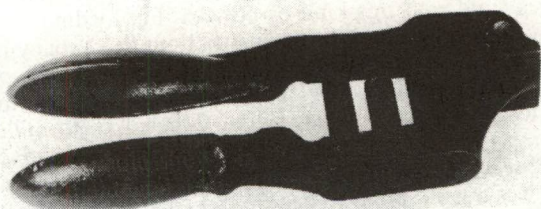

A

patented September 30, 1874 by William W. Winchester, the son of Oliver F. Winchester who founded the company, and was apparently produced for only a very short time. An illustration of it with directions for operation appear in the 1875 Winchester catalog reproduced in John Amber's Ten Rare Gun Catalogs 1860-1899. Even at that early date it was offered in 24 different calibers, only one of which, the .44 WCF, was a Winchester caliber. The designation "WCF" (Winchester Center Fire) was used by the company to identify cartridges developed by them.

Also advertised were bullet molds, wad cutters, and charge cups. These items were available separately or as a set. Bullet swages were also listed but regular cast bullets were recommended as satisfactory for ordinary use. Two features particularly distinguish this first tool from later ones: They are the two vertical cylinders or "studs" as they were called

in the catalog and patent, and the black Japanned finish. The type of seating and crimping chamber, extractor, and spoon shaped handles were to persist for several years in other models.

To reload a cartridge, the fired case was placed over the decapping stud and the handles brought together forcing out the fired cap. The case was pulled off the stud by hand and placed over the other stud. This has a depression in the top to accommodate the primer pocket as it projects inside the case (most modern cases do not have this protrusion but rather are flat across the inside of the head). A slightly concave capping pin on the upper lever seats the new primer. Again the case is removed by hand. After charging with powder and placing a wad on top of the powder, a bullet was placed in the case mouth and the assembled cartridge put into the seating chamber where the bullet was seated and crimped. Opening the handles caused a lever to withdraw the completed cartridge. Mr. Raymond Bell of El Paso, Texas, to whom I am much indebted for both information and an excellent chart, reports that the second edition of the 1875 catalog illustrates a different model tool; attesting to the short production period of this first model.

The mold furnished at this time was not described or illustrated. It may have been the iron handled mold produced for so many years and furnished with later tools. However, it may also have been the brass mold shown in (B). The handles and blocks, which are integral, are of



B

brass; the cut off plate, hinge pin, and other parts are of steel. Contours and dimensions are the same as on the iron handled molds except for sharper edges on the brass model. There are no identifying markings on any of these molds that I have examined. Interestingly, most carry a very small number stamped on each part. The numbers are uniform on each mold but differ from one mold to another and therefore may be serial or assembly numbers.

Although Winchester has no specific records of brass molds, the design certainly points to their manufacture. Some verification is found in an account relayed by Mr. Bell from

another Winchester collector of an open top Model 1876 rifle purchased long ago by a hunter employed by the railroad to provide fresh game for work gangs. With this .45-75 rifle was an early Winchester gold painted "Improved Reloader" (described next) and a brass mold. In another instance, this kind of Winchester tool and mold were cased with an F. Wesson rifle. However, it seems reasonable to assume that these brass molds are indeed a Winchester product and probably a very early one, perhaps their first type of mold.

We are indeed fortunate to have a second model tool in new condition and with its original cardboard box (C&D). This

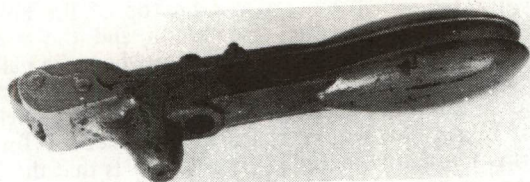

C

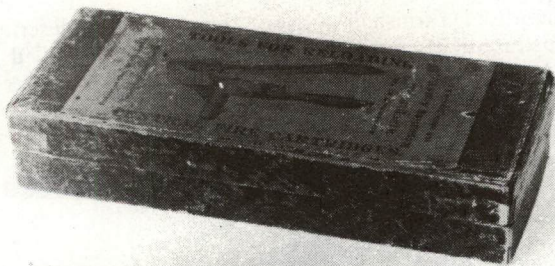

D

fine specimen was presented to me by Lon McCoy, who knew my interest in the early tools and efforts to research them. The finish is a gold or brass colored paint and stamped on the side near the hinge is the caliber, ".44 WCF." This tool, like the first one, is cast with the patent date on top of the hinge. The box is a rough finished black with the label "44 Winchester 1873) on the end and the tool pictured on the top; in addition, it is marked "Patented Oct. 20th 1874" and "Improved Oct. 1875." The factory designation was "Improved Reloader." It was

produced in two sizes: The large one, in .45-75 caliber, is pictured in (E). Except for its massive size, it is identical to the smaller one.

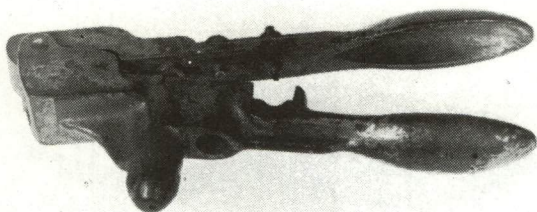

E

Instead of the large studs for decapping and capping, decapping was by means of a separate pin inserted in the seating chamber; when capping, the case was held in a hole in the lower handle. If the case had a Berdan primer it was extracted with the chisel attached to the upper handle.

The third type tool, not illustrated, was the second type but made without the Berdan chisel. An intermediate or

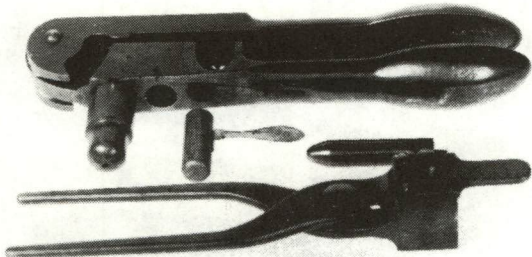

F

transitional model tool is illustrated in (F) and its box in

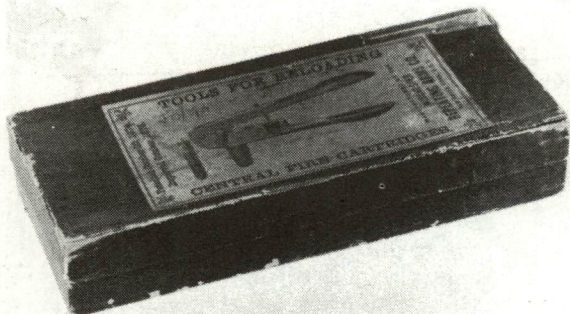

G

(G). While it has the spoon shaped handles of the earlier cast tools, it appears forged, and has a polished and blued finish. However, it has an improved case extractor, a pair of ears which pull the cartridge from the seating chamber. The

ironhandled mold was furnished along with decapping pin and brass charge cup stamped with the charge. This and all previous tools bear no company name.

The more commonly-encountered form of this tool is



shown in (H). The handles are plain, and it was available with or without the Berdan decapping chisel. The latter form is illustrated. In Mr. Bell's chart this is number 4. On the side shown are the manufacturer's name and address; on the opposite side appears the patent date (September 14, 1880) and the caliber, in this case 40-60 WCF.

The Winchester tool manufactured over the longest period of time is the fifth type. It is shown with mold and charge

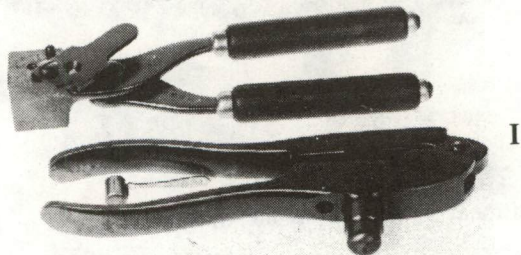

cup (I). Not shown is the decapping pin. Note the wooden handles on the mold, a feature that first appeared in the



June, 1890, catalog. The box is shown in (J). It is cardboard but differs from earlier boxes in having plain

black paper as covering. The only patent date on the box is the original one, October 20, 1874, although the November 7, 1882, patent applies also. This tool was offered for sale through catalog 79 (1914) after which Winchester no longer sold tools and molds.

Almost all Winchester loading tools were of the non-adjustable type. That is, they were designed to use one bullet shape and weight and seat it at a fixed depth and

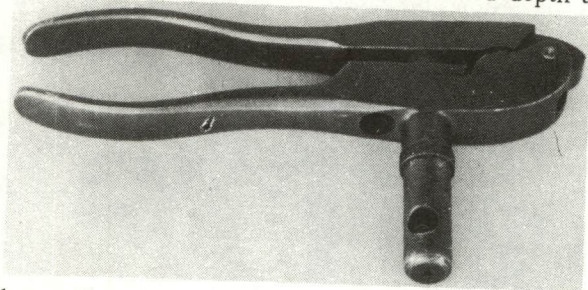

K

with a uniform crimp. The scarce tools shown in (K) and

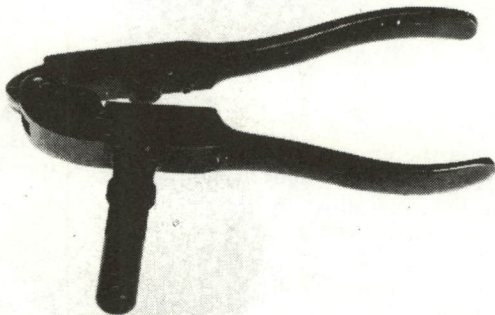

L

(L) are the exception. They were designed for loading large cartridges for use in single shot rifles where no crimp was needed nor even desirable. Tubular magazine repeaters, of course, required a crimped cartridge so that the bullet would stay in place despite magazine spring pressure, recoil, and random movement.

Both of the tools illustrated have what might be called single adjustable chambers, with which the bullet seating depth can be changed. A hole through the seating chamber is found on tools for patched bullets, perhaps to allow the bullet to be watched in the seating process and thus reduce the likelihood of a torn patch. This tool (K) is marked "40-70 REG," a designation for the .40-70 bottlenecked cartridge widely used in Sharps and Remington rifles. The

“REG” stands for regular as opposed to the later straight case cartridges. On (L) is found “40-70 S.S.G.” referring to the Sharps Straight for grooved rather than patched bullets.

The last three loading tools developed by Winchester were of the full-length resizing type. Perhaps this was prompted by their new 1886 model rifle with its large capacity cases. Such cases often swell in firing and thus make chambering and extraction of reloaded cases difficult. Full length resizing restores the case to its original dimensions.

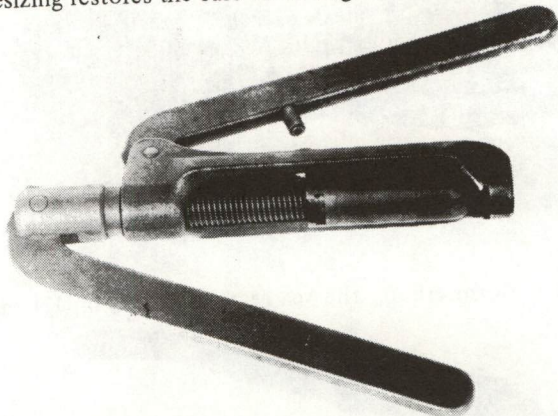

M

The first and scarcest of these is the New Model (M). In its operation the die is removed and the large lever used to cap the cases which have been previously decapped with a simple long pin struck with a hammer. Then the charged and assembled cartridge is placed in the die and the large lever turned, forcing the die down over the cartridge until it can go no further. Then the lever is turned the opposite way, freeing the cartridge, which is held by the rim at the bottom of the frame. The operation is slow and cumbersome but reasonably effective. Finish on these was black Japanned. The caliber was stamped on the die which could be interchanged to load a variety of calibers.

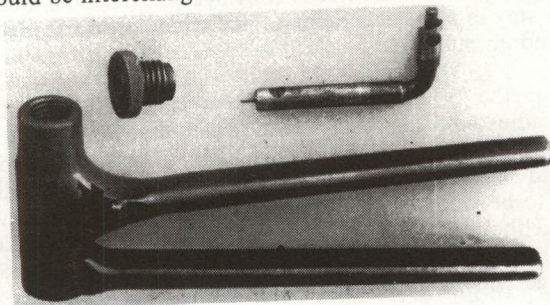

N



In less than two years the Model 1891 tool (N) was brought out; it lasted only a little longer. Though relatively scarce, these tools are more common than the New Model or 1888 tool. The 1891 tool is a beautifully finished mechanical marvel but about as slow as the 1888 tool which it superseded. To operate it, the cases were decapped by pushing or tapping out the old primer with one arm of the "L" shaped device. The case was then placed in the slot in the lower handle, the other end of the re-decapping device put in the opposite side and turned, pressing the primer into place. The handles were unscrewed several turns and the assembled cartridge pushed into the large opening on the bottom. Then the special plug (which has a fast left hand thread) was turned into place behind the cartridge and the handles turned closing the tool and forcing the cartridge into the die.

The final loading tool produced by Winchester and one which was not dropped until 1914 was the Model 1894. It was simpler, more compact, and faster to operate than either of the preceding full length resizing tools.

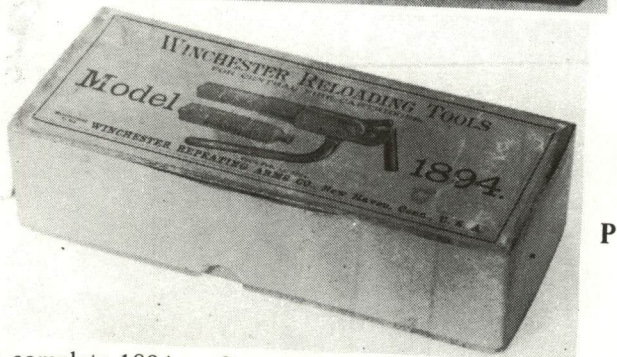
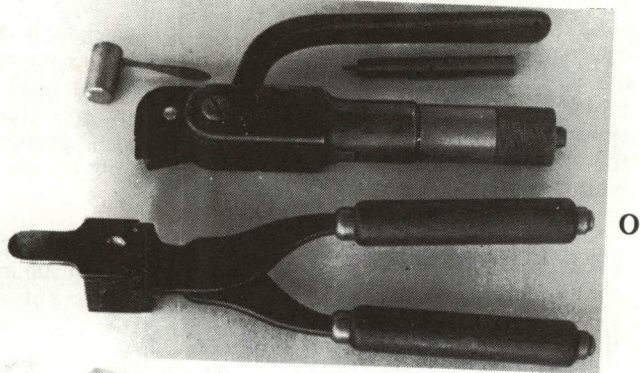

A complete 1894 outfit is shown in (O) and the box in (P).

To recap, the case was placed in a small cut-out place on the top of the tool and the lever pressed down to seat the primer. The die, which has knurling over part of it, was unscrewed and the assembled cartridge placed in it. Then the die was screwed back in as far as it would go. Pressing the handle and turning the die were alternated until the die would turn no farther after which the finished cartridge was removed. An interesting variation of this tool was reported by H.B. Albright of Detroit, Michigan. It reloads the .42 Russian Berdan cartridge and has a Berdan chisel and provision for holding the case while using it.

On at least two occasions iron-handled Winchester molds have been examined which bore no identification other than the caliber and "S. D. & G." Apparently these were made for sale by Schoeverling, Daly, and Gales, a New York concern.

Blank molds, that is, molds with no cavity cut in them, were available also. These could be custom chierred by gunsmiths to cast special bullets.

What appears to be a copy of the third Winchester tool is in the Ed Stephens collection. The contours are the same as those of the Winchester and it has the rough cast finish. However, there is no extractor nor is there any provision for one. Cartridges must be pushed out from the bottom with a rod. There is no name or other marking nor any clue to its identity.

We are indebted to Raymond Bell Jr. for the very thorough charting of Winchester tools and molds. (Q) His painstaking efforts make identification and historical placement of these items relatively easy.

WINCHESTER LOADING TOOLS AND BULLET MOLDS

DESCRIPTION OF MODEL OR TYPE	NAME GIVEN BY COMPANY, PER CATS.	PATENT DATES	CATALOG LISTINGS FIRST	CATALOG LISTINGS LAST
1. Cast Iron - per original patent design	"The Reloading Tool"	Oct. 20, 1874	1875-1st Edition	See note A
2. Cast Iron - modified, and with Berdan decapper	"Improved Reloader"	Oct. 20, 1874	1875-2nd Edition	May 1, 1879 (See note B) April 1, 1882
3. Cast Iron - same as above, without Berdan decapper	probably continued as "Improved Reloader"	Oct. 20, 1874	May 1, 1879	(See note C) Cat. No. 56
4. Blued steel - lever type, with or without Berdan decapper	See note D	Oct. 20, 1874	Jan. 1, 1884 (See note C)	Jan., 1896
5. Blued steel - lever type, without Berdan decapper	"The Lever Tool"	Sept. 14, 1880	Sept. 1, 1882	Cat. No. 79 1914
6. Cast steel - black Japan finish, Two levers - interchangeable dies.	"The New Model"	Nov. 7, 1882 Jan. 24, 1888	Feb., 1889	July, 1890
7. Blued steel - two levers, left hand thread cap and right angle capper-decapper	"Model 1891"	Mar. 17, 1891	March, 1891	Oct., 1893
8. Blued steel - single lever, screw-in die.	"Model 1894"	Feb. 13, 1894	Cat. No. 52 April, 1894	Cat. No. 79 1914

**BULLET MOLDS:**

The June, 1890 catalog shows wood handles for the first time.

T.E. Hall, Curator Winchester Gun Museum, says this tool last listed in 1875, 2nd edition, yet Parsons, page 111, The First Winchester shows it in what is supposed to be an 1878 catalog page reprint.

Note A: A separate Winchester, or pin type, decapper came with most of the Berdan chisel equipped tools.

Note B: Per catalogs, this tool was superseded by "The Lever Tool," though the model patented September 14, 1880, may have been made and sold to the trade prior to its first listing in the January 1, 1884 issue. Such things did happen, even in the case of guns.

Note C: For years this tool, together with "The Lever Tool," was listed simply as "Tools For Reloading Central Fire Cartridges." When it was discontinued the remaining one was designated "The Lever Tool."

Note D: Notice that some catalogs are designated by number and date, others by date only. This is correct. A numbering system seems to have been carried in the company books in some way, yet the first issue actually numbered appears to be No. 52, April, 1894.

compiled by Raymond Bell, Jr., El Paso, Texas

## REMINGTON, U.M.C. and B.G.I.

The tools and molds produced or sold by Remington, Bridgeport Gun Implement Company, and Union Metallic Cartridge Company will be considered together in this chapter because of their interconnections in business. Indeed, the "REM-UMC" headstamp on cartridges was a familiar one for many years and the "U" is still to be found on Remington rimfire cartridges.

Of these three concerns, Remington is the earliest and best known, going back to the early nineteenth century when Eliphalet Remington first produced rifles, through E. Remington and Sons, to Remington Arms Company. Union Metallic Cartridge Company was begun in 1867 by Schuyler, Hartley, and Graham who, through Marcellus Hartley, controlled E. Remington and Sons. Some time after this the U.M.C. Company formed the Bridgeport Gun Implement Company to make the various loading and cleaning accessories needed with the breech-loading arms then coming into popularity. Bridgeport, Connecticut, directories show it in five different locations from 1878 to 1907 and indicate that at the turn of the century the concern also made hardware and bicycles.

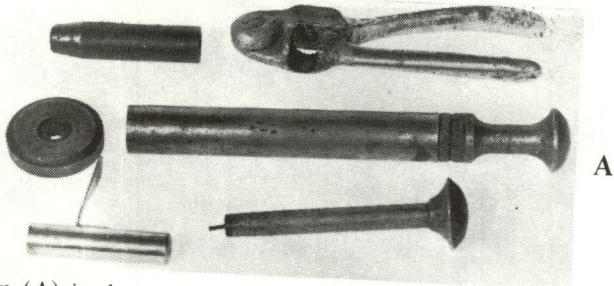

In (A) is shown a set of Remington rifle cartridge loading tools. This particular set is part of an old bear hunter's outfit now owned by William B. Richardson and accompanies a Remington Hepburn rifle chambered for the .40-3¼" Sharps cartridge (3¼ refers to case length). The case is decapped by placing the head in the circular base and pushing out the cap by hand pressure or a light tap of a mallet on the decapper. Recapping is by means of the tong capper. The charged case is then placed in the cylindrical shaped die or loader and the bullet forced into place by the plunger. Leather washers have been added to this plunger to adjust seating depth but they were probably not on the tool when originally produced. Also shown are the charge cup

and wad cutter. The only markings are the caliber, stamped on most of the items. These cappers have nicked handles with gold paint in the area of the hinge. Remington catalogs of the 1870's list the reloading implement set at \$5.00. It was usually put up in a light green cardboard box.

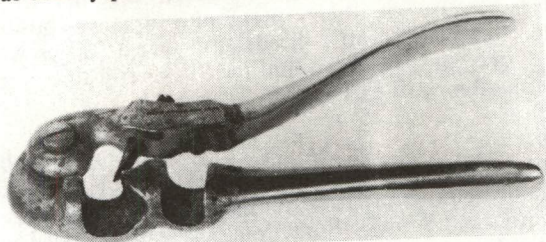

B

A capper with Berdan decapping chisel (B) was probably also produced by Remington. They are more commonly found in shotshell size but a few, like this, are for rifle cartridges.

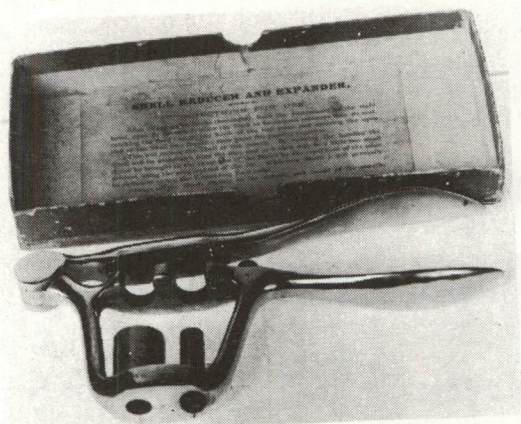

C

A special Remington reloading item available separately was the shell reducer and expander (C). The writer erroneously identified this as a Sharps product in an article appearing in the January 1956 Gun Report. As with other Remington items the only marking is the caliber. This appears either on the top of the upper handle or on the side of the bottom of the tool. The finish may be either nickel or red paint. To operate, the case is placed with its mouth in the reducing die and its head engaging the extractor hook on the upper handle. The case is then forced into the die. Then the mouth is expanded in a similar manner on the expander plug. This item is shown beside its red cardboard box, with directions for use printed inside the cover.

An extremely scarce set of Remington pistol loading tools

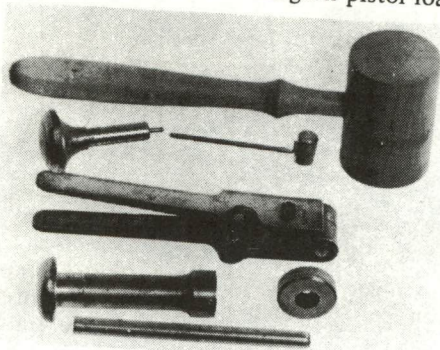

D

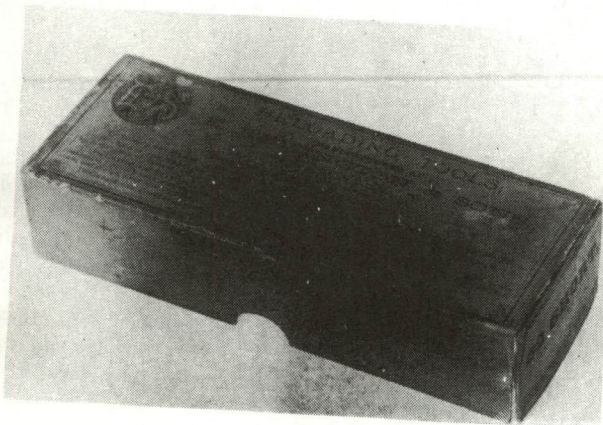

E

is shown in (D) and its box in (E). The caliber is .32 short, a size used in various pocket pistols as well as a few rifles. Directions for use appear on the top of the box. This differs from rifle sets particularly in the mold and capper being combined. It is quite similar to the Smith and Wesson early mold-capper illustrated in the Smith and Wesson chapter but differs in that its handle ends are more rounded and the capping is done in the opposite direction. The extra rod is probably for driving the case from the loading die and may not be original. No reference is made to it in the directions. Cases are capped by being placed in a hole at the side of the bullet cavity, putting a cap in place, and squeezing the handles together. The mallet was to more easily decap and seat bullets. None of these items is marked.

In addition to the mold-capper just described Remington

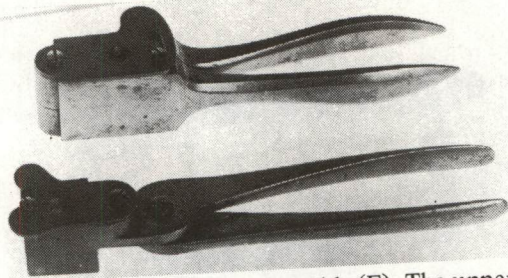

F

produced two general types of molds (F). The uppermost is the earlier type. It is of beautiful line and finish. All the surface is plain polished steel except the sprue cutoff, which is a shiny blue. This one is stamped "44 EXL" on the side of the block, presumably for .44 extra long. The bullet is round nosed, grooved, and has a distinctive tapered base but is not a heel bullet. No doubt the base taper facilitated loading. Both this mold and the one below it have relatively thin cutoff plates.

The lower mold is the more commonly found Remington mold although even these are not often seen. The finish is like that described above, though some may have been all blue. The caliber may be found on the bottom of the block, the handle, or the cutoff plate. The designation may be as brief as "50" or as detailed as 38-40-245, a special Remington cartridge not to be confused with the 38-40 WCF cartridge. All those I have noted are for grooved, not patched, bullets, but some of the latter may have been made.

The Union Metallic Cartridge Company marketed few molds and seemingly fewer tools, if the number encountered

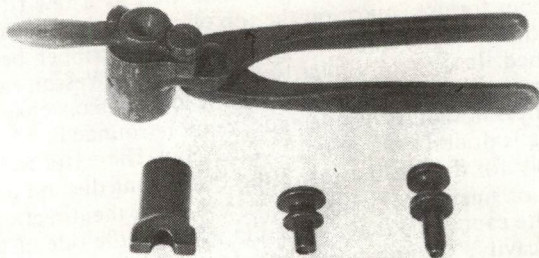

G

is any indication. (G) shows a mold and tools all of which are marked "UMCCo." The caliber is "32 L O" which indicates .32 long; the "O" probably stands for outside lubricated, as this is the kind of bullet the mold casts. The



finish on these items is red. To use the tools, one plunger expands the case mouth and doubles as a means of pushing a loaded cartridge out of the die. The other is the bullet seater. The writer has encountered only one other such tool. It was of identical design, slightly smaller, and for caliber .22. It may have been for the .22 Maynard centerfire or possibly for loading the .22 empty primed rimfires once available.

The molds are occasionally found. One in my collection is in .50-90 caliber for the patched bullet; another once owned was in .45-70 Marlin and cast the distinctive flat nosed bullet. All those examined were marked on the bottom of the block.

The best source of information on Bridgeport Gun Implement Company products is to be found in The Canadian Journal of Arms Collecting for May, 1966, in which was reprinted an entire 1882 catalog of this firm.

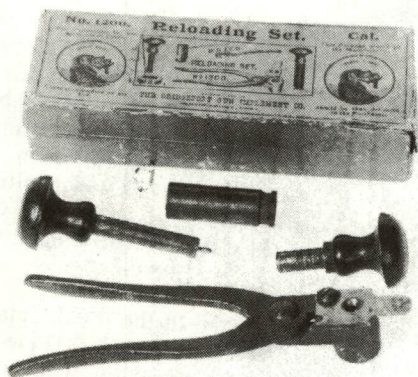

Set Number 1200 (H) is nearly complete, lacking only a decapping base, charge cup, and the unusual one piece hook capper shown on the box cover. The mold is painted red, though black Japanned ones are also found. On the cutoff plate is "38 S & W" and "B G I Co." A more expensive set was numbered 1202 and included in addition a mallet, wad cutter, hinged capper, and a thumb screw crimper.

The unusual three-handled tool in (I) was designed to extract and seat Berdan primers. A small chisel emerges from the capper face when the small handle is moved thus hooking on to the cap and making extraction an easy matter. In practice it does not work very well. The tool has red Japanned handles with polished steel elsewhere. This



particular tool was designated for .42, .43, .44 caliber, no doubt referring to a series of cartridges having a similar head size, the .42 Russian Berdan, .43 Spanish or Mauser, and .44-77 Sharps and Remington. It was also available in other calibers and shotgun gauges.



Although (J) is shown in the B.G.I. Co. catalog, this one is marked "38 ev'l." and "S.D.&G.". The former probably means ".38 Everlasting" indicating use in an "everlasting" type case. What cartridge this might be is open to speculation, but probably Ballard's .38-50-255. The initials stand for Schoeverling, Daly, and Gale, a New York concern that probably purchased it from B.G.I. Co. It, too, has the red painted handles.

Among the other loading items listed in the B.G.I. catalog are "Sharps Molds, Forged Steel with Cutter." These are identical with the typical Sharps iron mold with sprue cutter on the end illustrated in the Sharps chapter except that they are stamped "B.G.I. Co." and "Sharps Mold" in addition to caliber. They are also seen with "MFA Co." on them to designate Marlin Firearms Co.

## MARLIN and BALLARD

The names Marlin and Ballard are inseparably connected in the arms field. In fact, until a few years ago Marlin advertisements frequently pointed with pride to their Ballard-type rifling, to which they attributed great accuracy. Ballard rifles were manufactured by a series of companies, but it was the later ones, those made by J.M. Marlin and then Marlin Firearms Co., that achieved great fame on target ranges and in the field. These were chambered for a variety of centerfire, reloadable cartridges, and tools were supplied especially for them. A tool designated specifically for the Marlin was also produced.

The Ballard tools consisted of a ball (bullet) seater, re- and

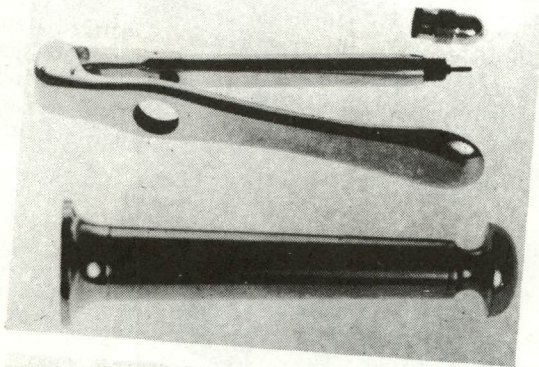

A

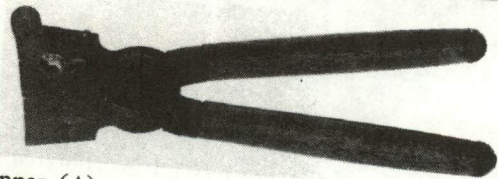

B

de-capper (A), and mold (B) as shown, and also a plain powder scoop and wad cutter. The re- and decapper and ball seater were nickel plated. The former had the caliber marked on the inside of the lower handle but was otherwise unmarked. A knurled cap screwed over the decapping pin to protect it. In use the pin was simply pushed downward to force out the old primer. A gentle mallet tap could assist but great pressure was not needed with the soft primers of that period. Ball seaters are found with the caliber marked either on the top of the plunger or on the bottom of the base. The one illustrated is marked "40-63" on the top. Another is marked "40/65" on the bottom. The latter tool

is for one of the early thick-mouth true everlasting cases while the .40-63 is one of the later series, actually the .40-70 Ballard cartridge but with a heavier case and consequently reduced powder capacity. The bullets were usually paper patched and therefore no crimp could be used as it would tear the patch. The bullet was started into the charged case by hand and the assembled cartridge placed into the seater from the bottom. Then the plunger was forced by hand down on the bullet until it was firmly seated on the wad which had been placed over the powder charge. In many loads there were two card wads over the powder with a disk of lubricant between them, since the paper patched bullet was dry. Any pick-like object could be inserted in the groove in the bottom to remove the finished cartridge.

These items could be purchased separately or in the set described above. Other loading accessories offered were a bullet swage for squeezing bullets to very accurate shape and size before patching, a case sizer to reduce expanded cases, and what the 1888 catalog referred to as a "Wilkinson Loader" which may be the powder measure of

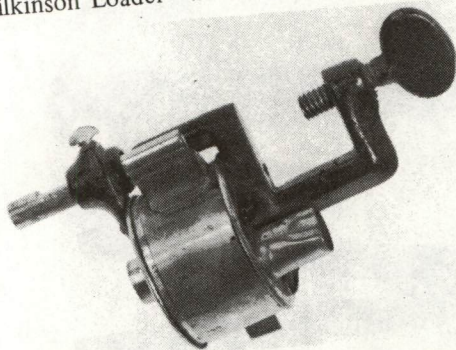

C

which the metering part is shown (C). It is calibrated on the side in ounces of shot, drams of powder, and grains of powder. On top is "J.D. Wilkinson. Plattsburg, N.Y. Pat'd July 24, 1877."

In the 1898 Marlin catalog, although Ballard rifles had been discontinued for several years, the Ballard accessories were still offered for sale. It was stated that the line was being closed out and that complete sets were not available in all calibers. It is interesting that the Ballard tools are the same as shown in the Wufflein catalog and that even the arrangement and price list order are the same but no mention is made of Ballard.

The mold shown (B) is marked "M.F.A. Co." and "38-255P" on the cutoff. It casts the patched bullet.

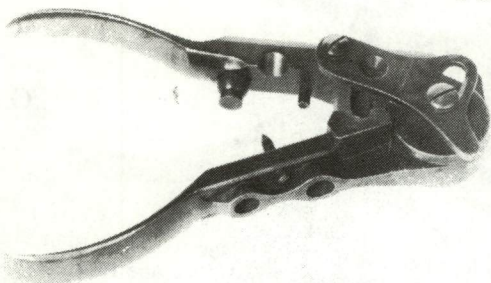

D

The Marlin tool (D) was distinctive in appearance and in its high quality of workmanship. It was patented by the renowned gun designer, John M. Browning, on October 4, 1881. The bullet mold cavity was within the tool handles, rather than on the end as on the Ideal line. What appears to be a bullet sizer is a wad cutter. The original instruction sheet (E) was provided by Don Martin and explains the operation of the tool. Note that Berdan primers could be decapped with the chisel and that a decapping pin (plug) was used for regular primers. The finish was blue and all specimens seen have what appears to be serial numbers. H.A. McCallum of Monroe, Oregon, assembled a number of these tools and noted numbers from 1318 to 7088. No duplicate numbers were noted.

An earlier version of this tool, one almost identical to the

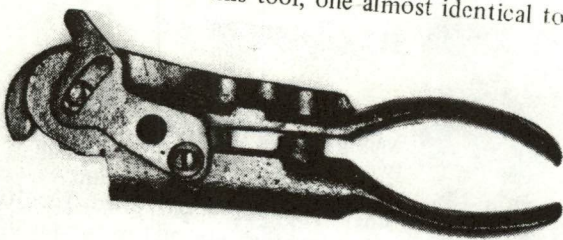

F

patent drawing, is owned by Frank G. Newton, Jr. (F). It has a rough finish, slightly different contours, and is marked on the outside of the loading chamber "J.M. Browning, Ogden U.T. .44W."

Still another tool is shown here because it appears to be related in many respects to the Marlin tool. The writer has

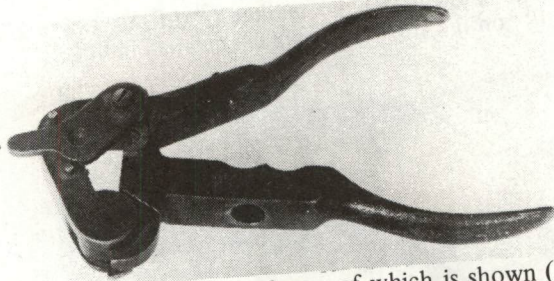

G

seen it in two sizes, the larger of which is shown (G). The smaller is identical except that it lacks the Berdan chisel decapper. As with the Marlin tool, this one has the bullet mold within the hinge and the seater in the handle. H.A. McCallum reports finding one of these with a bronze colored painted finish like that found on the early Winchester tools. Its only marking was "45-70." The one pictured here bears no markings, nor has it any finish.

Marlin catalogs also listed the Ideal line of loading tools and, at one time, Marlin was identified on the Ideal Hand Book cover as Ideal's successor. Ideal tools made at this time are found stamped with the Marlin name. The "M.F.A. Co." stamp is also found on bullet molds identical to the early iron-handle Winchester molds and must have been made by the latter or purchased from a common source.

In addition, molds identical to the Sharps are found marked "M.F.A. Co."

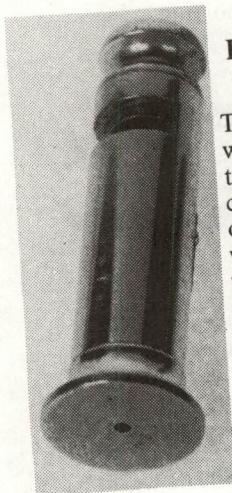

H

The two piece seater shown in (H) may well be a Marlin item. I have only seen two of these. The only marking is the caliber, 40-60 on this one and 45 on the other. They are nickel plated. The "HJG" visible on the side of the one illustrated was stamped there by its former owner, Henry Gier. The only reason for placing this in the Marlin section is that it accepts the .40-60 Marlin cartridge but not the .40-60 Winchester, thereby suggesting Marlin manufacture.

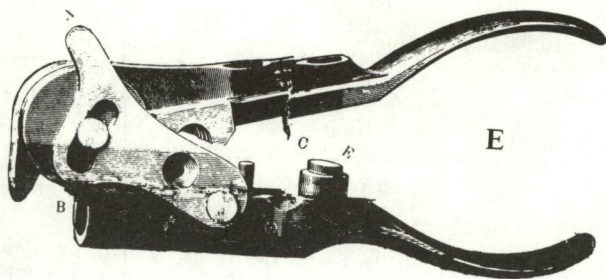

## MARLIN LOADER.

This tool is the *only* complete one made. It combines in one piece an entire reloading outfit, consisting of Bullet Mould, Wad Cutter, Decapper, Recapper and Crimper. No other make of tool has the Bullet Mould and Wad Cutter. Although providing for all these necessary functions and rendering ~~double the service of any other tool~~ on the market, it is very compact and in weight much less than others.

~~If the mouth of the shell, after firing, should be dented or cut of~~ shape, it can be rounded out on the shell scraper at *A*.

For removing the primer from a shell which has only one vent, use the decapper plug at *B*; if several vents, use the pin at *C*.

To recap the shell, insert same at *D*, and after placing the primer in its pocket, bring the handles of the tool together.

*E* is the Wad Cutter, which will do the work with less trouble and more perfectly than an ordinary tool for that special purpose.

Be careful to recap the shell while empty, which will avoid dangerous explosions. Then insert the powder, wad and ball, after lubricating the latter, into the shell and place it in the chamber at *B*. By drawing the handles apart the shell is crimped and the ball firmly seated. Bring the handles together again and the finished cartridge will be lifted from the chamber.

Do not use powder which is finer than F. G., and by all means avoid the high grades, such as Electric, Diamond Grain, &c.

Always keep your mould and lead very hot while using, as otherwise a perfect ball cannot be produced.

THE MARLIN FIRE ARMS CO.,  
MANUFACTURERS,

New Haven, Conn.

## MAYNARD and STEVENS

Dr. Edward Maynard was a dentist, but he was also a most prolific innovator in the firearms field. His rifles, tape primer, and a wonderful variety of cartridges provide present-day collectors with much to think about, puzzle over, and enjoy. Along with the guns and cartridges went an assortment of loading tools and molds no less interesting. The Maynard line was eventually acquired by Stevens, who put out a limited line of their own tools. For this reason, the two makers will be considered together.

Maynard rifles, cartridges, and the tools to load them were produced by the Massachusetts Arms Company of Chicopee Falls, Massachusetts. Their molds are generally so marked, although other loading items not identified with the name frequently carry other identifying marking, such as patent dates or caliber.

The three principal types of Maynard cartridges are those identified by the factory by their dates of introduction: 1865, 1873, and 1882. The first of these is most commonly exemplified by the thin but wide rimmed .50 caliber Civil War carbine cartridge, which was ignited by fire from a separate primer or Maynard tape through a small hole in the head of the cartridge. They were also made in .35 and .40 caliber. Only a ball seater was required in reloading this type, since no primer was involved. The 1873 type had a very thick head, a five piece case (including an iron anvil), and used Berdan primers. The final type was a conventional cartridge using the Winchester or Boxer type primer.

Berdan primers do not have the familiar central flash hole found on modern American cartridges; rather, they are simply cups holding the priming mixture. The anvil is a part of the cartridge and the flash holes are located at the side or center of the anvil. Thus decapping requires some means of prying out the fired cap.

The tools shown (A) were especially designed for use with the 1873 Maynard cartridge. On the right is the Hadley cap picker. It was hooked over the head and a small chisel, actuated by the handle, penetrated the side of the primer which was then pried out. The heads of 1873 cartridges have grooves on each side of the primer which nicely accommodate the Hadley chisel. For recapping the wide rimmed cartridge the special capping tool of plier type shown here was provided. The cap picker is stamped only



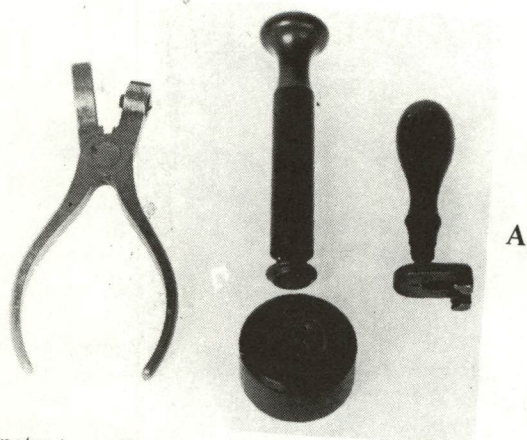

"patent applied for," while the capper is unmarked. No caliber designation was necessary because all of these cartridges except shot shells had the same head size.

Seating the bullet properly required a "loader" of the kind shown. These, of course, were of differing dimensions to fit the various cartridge lengths and diameters. There is a small hole in the center of the head to serve as a vent to permit air or excess bullet lubricant to escape. On this specimen 40-1 is stamped above the vent and 70 G below it. "40" is the caliber and "1" probably stands for the bullet shape (a point to be discussed in connection with the molds). "70" would be the powder charge in grains and "G" very likely stands for the grains of powder. In use, the assembled cartridge was placed in the seater and the latter pressed down firmly on the wooden base until the bullet was seated upon the charge.

The loader or ball seater for the Model 1882 cartridges was similar to that for the earlier Maynard cartridges except that the smaller and less-projecting rim required that the sides of the loader be tapered, thus making it possible to get a good hold on the cartridge head to withdraw it from the loader chamber. The one shown (B) is for the .32-35 Maynard cartridge. The markings are "32", "P", "35", "G", and "N". The "P" may stand for "patched" to indicate the bullet type and the "G" is probably for "grains" to indicate the powder charge. But the "N" is more difficult to guess. It might mean "naked" to indicate that this type of bullet could be used also. The "naked" bullet was simply one not using a paper patch. Actually it was a regular grooved, grease lubricated bullet.

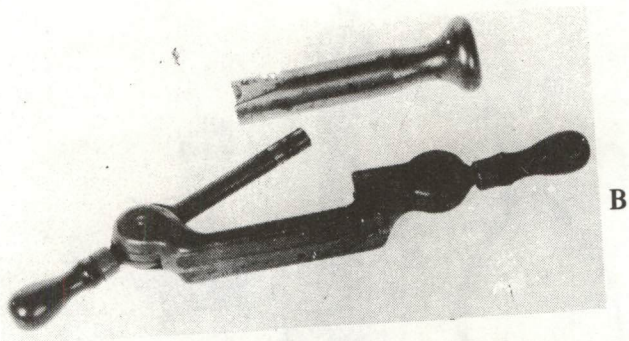

The device shown with the 1882 loader is a Hadley re- and decapper. Since the primer on the 1882 series of cartridges was of the familiar Boxer or Winchester type as seen on current American cartridges, a different decapping method was desirable. To operate this tool the fired case was put on the rod or thimble and lowered to a position in line with the handles. Then the left handle was raised, causing the decapping pin enclosed in the thimble to push out the fired primer. A new primer was placed in the pocket and the other handle raised, thus seating it. This tool is finished with the familiar gold paint. It bears no identifying markings. The handles are, incidentally, spring loaded so that they return to position automatically.

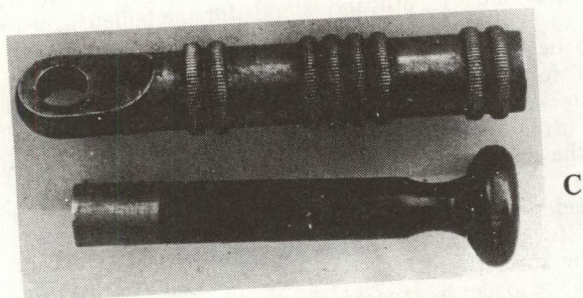

The Maynard bullet lubricator pump (C) carries no markings. Grease is forced through a hole into the grease groove of the bullet which has been placed in the large hole in the end of the device. Although this uses a wood plunger, one illustrated in Gould's Modern American Rifles, published in 1892, shows a winged screw to exert the pressure. Perhaps that was a later model. The head into which the bullet is placed screws off permitting other sizes to be used. Maynard bullets have but one grease groove, necessitating only the one grease hole.

In contrast to the loading tools, the Maynard bullet molds carry the company name "Mass. Arms Co." and "Chicopee Falls." This is stamped on the side near the hinge. One is

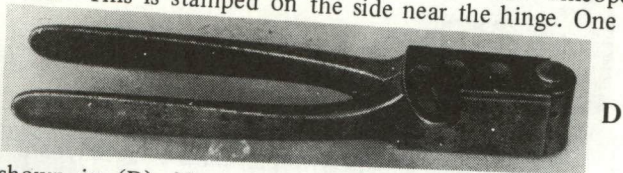

shown in (D). Note the hole in the hinge, perhaps for lubricating, though it would seem that at casting heat oil or

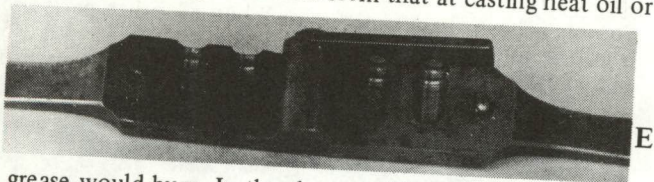

grease would burn. In the close-up (E) two bullet shapes are shown. The more pointed one was designated the number 1 and the cylindrical bullet number 2. There was also an extra long one referred to as the number 3. On the side of the mold, the numbers "1" and "2" outside of the respective cavities identifies them. Various combinations of cavities are found; some for identical bullets, some like this, and occasionally for two different calibers to fit the interchangeable barrels so popular with Maynard rifles. The Civil War Smith carbine mold was identical to this except that there was only one cavity, because of the large bullet diameter.

One of the rarest of all factory bullet molds is that for the



explosive bullet (F). These are listed in the 1885 Maynard catalog reproduced in L.D. Satterlee's Fourteen Old Gun Catalogs. They were available in .40, .44, and .50 caliber. The hollow point plugs produced a hole in the point of the bullet just the correct size for a .22 blank cartridge and a shoulder on the plug resulted in a counterbore which

protected the rim of the blank.



This double cavity mold (G) is presumed to be Maynard. A quite similar one is so labeled in Grant's book, Single Shot Rifles. The caliber, .22, is one used by Maynard and Stevens. There are no markings. While all other parts are iron, the screws are brass. Similar molds in .32-35 and .35 caliber have but one cavity. Since these calibers were also used by Stevens it could be their product.

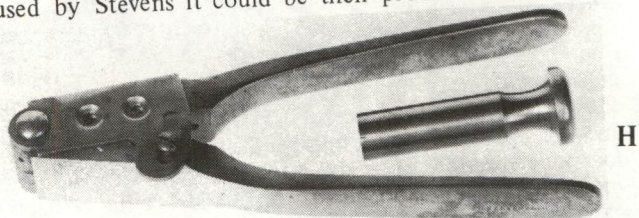

Although the bullet seater and mold shown in (H) look like Maynard items, they are actually Stevens. The mold is marked on the right handle "J. Stevens and Co." In addition to the marking, it is distinguished from the Maynard by wider handles and particularly by the cutoff working in the opposite direction. The bullet seater bears no identification but was found with it. When first seen by the writer, these items were accompanied by a wooden decapper of the plunger type. However, when they were acquired some time later, this item was missing and therefore was not available for illustration. A recently reprinted Stevens catalog of 1877 lists double molds of .38 and .44 caliber as well as a "Combined Capping and Loading Implement" in the same calibers. Homer Fisher's catalog of 1880 reproduced in Satterlee's Ten Old Gun Catalogs has a similar listing.

In addition to these items, Stevens had a special model of the Ideal tool and also the Pope line of loading accessories. The Ideal tool had the designation 6-A and was like the Ideal number 6 tool except that it worked from the opposite direction. Compare this tool (I) with model number 6 in the chapter on Ideal to see this difference. Calibers available were the Stevens .32-35, .32-40, 38-35, and .38-45, all of the everlasting type. Tool number 6A

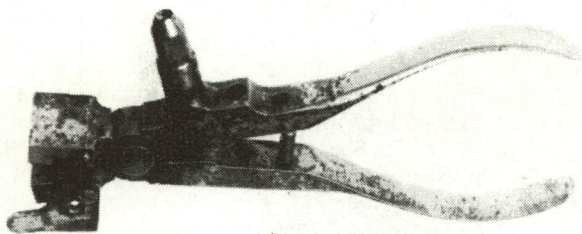

I

appears in the 1888 Stevens catalog in Satterlee's Fourteen Old Gun Catalogs. It is stamped with the usual Ideal markings but the cutoff is marked "For Stevens Arms Co., Chicopee Falls, Mass." The caliber of the tool pictured is .38-35 Stevens.

Harry Pope, probably the most famous of all custom barrel makers, became associated with Stevens and the special line of Stevens-Pope accessories was produced. It included the

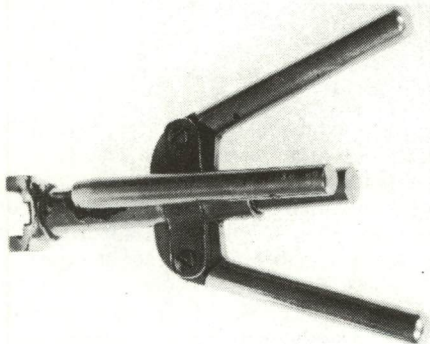

J

re-decapper shown (J), bullet mold, lubricating pump, and a duplex powder measure to drop a priming charge of smokeless powder before the regular charge of black powder. The 1902 Stevens-Pope catalog was reproduced in Satterlee's Fourteen Old Gun Catalogs and illustrates these items. They appear to be identical to those made and sold by Pope in his own shop. These items are also discussed in Smith's book, The Story of Pope's Barrels.

## SHARPS

One of the most romantic names in the field of American firearms is that of Sharps. As "Beecher's Bibles" and as the chosen weapon of John Brown before the Civil War; as the choice of Berdan's Sharpshooters; and as buffalo rifle supreme, the Sharps was indeed an important part of our nation's history.

Although bullet molds and perhaps some other reloading equipment was available with the combustible cartridge models, our concern here is with the tools and molds of the metallic cartridge period. A group of these items is shown in (A).

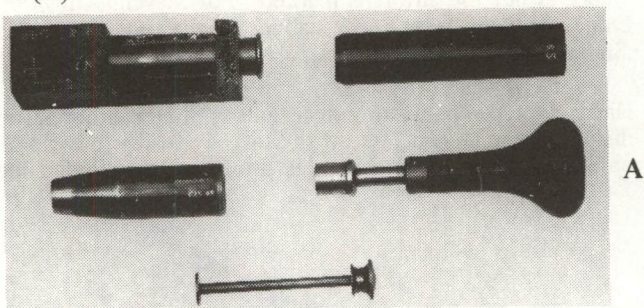

The rather completely marked item at the upper left is an early bullet seater and is shown with a case inserted. All the descriptive markings, however, are concerned with the bullet. They presumably stand for .44 caliber patched ball  $1\frac{1}{4}$  inches long: such a bullet was advertised in the 1876 Sharps catalog price list reproduced in Fourteen Old Gun Catalogs by L.D. Satterlee. It weighed 450 grains and was designated for reloading the .44-2  $5/8$ " case with 90 grains of powder. The early instructions, though, say to use the seater only for greased bullets, and to place the bullet in the seater, after which the charged case was pushed in.

In the upper right is the later and more common bullet seater. Like the earlier one, it is simply a one piece die but it was designed to be pushed down over the assembled cartridge. This not only seated the bullet firmly on the charge but also centered it properly. The later type seater may be marked either around the top or on the top. The other end receives the cartridge and a chamfered edge makes removing the case easier. In the one illustrated the markings are "45 2  $1/10$  420" meaning the .45 caliber cartridge using a 2  $1/10$ " case and firing a 420 grain bullet.

This was Sharps' equivalent of the .45-70 although it was customarily loaded with 75 grains of powder. It has a blued finish.

Below the early seater is a Sharps wad cutter and at the bottom of the picture the wad push-out plunger which accompanied it. The wad cutter is stamped with the company name and the caliber, however it may be found bearing only the caliber marking. The cutter has a bright blue finish. The plunger is steel with a brass head.

The remaining item is a wad seater. In target loading only a single paper wad was used between the powder and the bullet. In other instances a wax lubricating wad or "disk" was sandwiched between two card wads. Seaters are found both unmarked and stamped with the company name. They were probably the "followers" listed in the Sharps catalogs.

Other accessories mentioned in the catalogs were the loading tube, a long funnel which allowed the maximum powder charge to be loaded, cap awl for decapping the Berdan primers used in Sharps cartridges, powder charger (measure), ball swage, and case mouth sizer. Also small corks were available for use in filling the case when a reduced charge was used.

Sharps molds were quite distinctive. There were two types. The more common one was of steel and was very similar to those furnished with the combustible cartridge models of

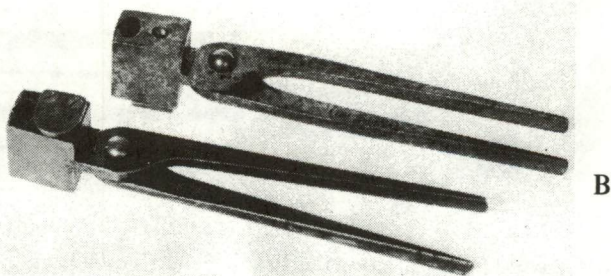

the Civil War period (B). The most distinguishing feature is the sprue nipper at the end of the mold blocks. Lead was poured into the small hole at the top. The bottom of the cavity was covered by a plate which had a convex protrusion that produced a dished base in the bullet. After cooling, the sprue was nipped off and a paper patch wrapped around the bullet. The "tail" of the patch was pushed into the hollow base of the bullet.

All but one of the Sharps molds seen by the writer are for patched bullets. However, one in the Charles Bradford collection is for the "naked" bullet with grease grooves. These steel molds are usually marked with the Sharps trademark "Old Reliable," as well as "Sharps Rifle Co., Bridgeport, Conn.," the caliber, and bullet weight. Also both handles are stamped with a number which was probably used in assembly to keep the two halves together. One of my molds also gives the bullet length, 1 1/10 inches. This same type of mold may be marked with the stamp of Marlin Firearms Co., or Bridgeport Gun Implement Co.

Far less common than the steel mold is the brass one shown

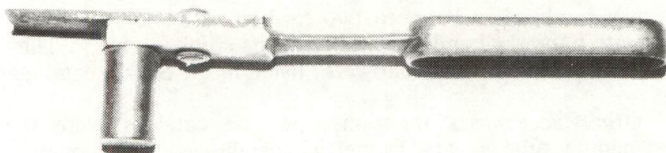

C

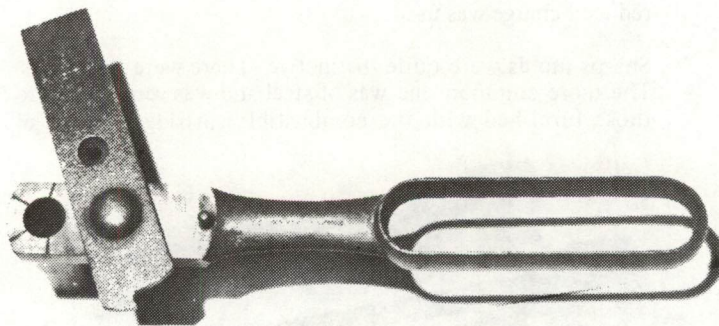

D

in (C) and (D). It is from the Frank Sellers collection and he was kind enough to furnish the photographs of it. The cutoff is steel. This particular mold is for the .44-520 bullet.



## SMITH and WESSON

The earliest Smith and Wesson arms fired the volcanic cartridge; later they used rimfire cartridges. With these there was no need for reloading tools, but with the addition of centerfires to their line, reloading became feasible, and in fact desirable. The firm promptly developed loading tools of a quality consistent with the fine workmanship of their arms.

Smith and Wesson loading implements were ordinarily furnished in sets. The earlier set differed from the later one primarily in the design of the bullet mold-capper, though the boxes in which they were supplied changed also.

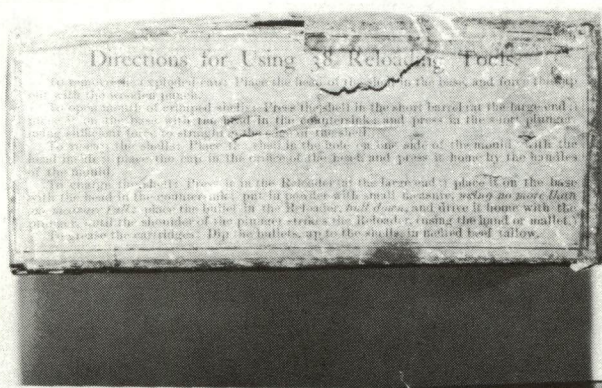

A

The cover of an early box is shown in (A). The box is blue with a label on one end reading "38 Reloading Tools, Smith & Wesson, Springfield, Mass., USA." This end label and the top are white.

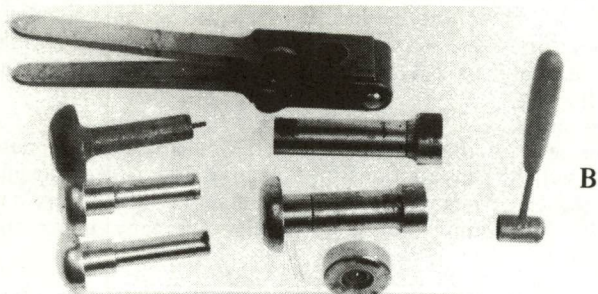

B

All the tools (B) appear to have a simple polished steel finish, the mold being darkened by heat from casting

bullets. There is a single bullet cavity and a hole into which the decapped case was placed for priming. The capping projection is adjustable for cap seating depth. Note the similarity between this mold and the Remington pistol bullet mold described in the Remington chapter. The tools are also quite similar.

Fired cases were decapped with the mushroom shaped wooden decapper while placed on the metal base. Then the case mouth was expanded with a tapered plunger. After recapping the case was placed in the "reloader" die, a charge of powder poured in from the dipper, and the bullet placed in the top. The seating plunger was then forced down upon it by hand pressure or by tapping with a mallet. The set illustrated has long and short seating plungers, apparently for loading gallery loads as well as full charges. A very early set illustrated in Jayco's reproduction of a Smith and Wesson catalog shows only the one plunger, no mouth expander, a plain all metal powder dipper, and wooden mallet in addition to the mold-capper and decapper. Apparently these sets increased in sophistication and flexibility over the years.

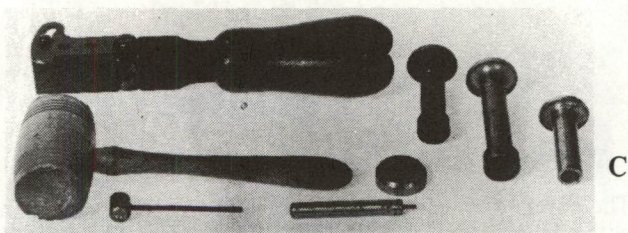

The later type of loading set is represented by (C). Note the excellent workmanship on the mold-capper. The metal parts are blued and the handles varnished walnut. There are two cavities, one for the regular conical bullet and the other for a round ball. The tools function just as those in the earlier set.

This set is contained in a black, cloth covered cardboard box with the instructions printed inside the cover. The end of the box bears a red label and is marked "38 Military and Police Reloading Tools" with the company name and address.

The recommended lubricant was tallow, to be put in the grease groove or, in the case of the round ball, on top after seating.

Smith and Wesson chambered some of their arms for Winchester cartridges such as the .44-40 and .32-20; for reloading these they recommended using Winchester tools.

An interesting variation on the mold-capper is one in the collection of Bob Nadler. It has four .32 caliber round ball cavities. Two of these open to the top of the block and two to the bottom. There are accordingly cut off plates on both top and bottom. This unusual mold is apparently a factory product.

The reproductions of early Smith and Wesson catalogs published by Jayco, Newhall, California, are excellent sources of information on these tools.

## IDEAL

In any collection of old loading tools those most commonly seen are made by the Ideal Manufacturing Company. Although superficially similar in appearance, a closer examination of the tools and a glance at the early Ideal hand books reveals a number of variations or models designed with specific tasks in mind. And in addition to the familiar nickel plated tong tools either with or without molds attached, there was a variety of other loading accessories deserving of attention.

The principal patents on the tong tools seem to be those dated February 11 and December 23, 1884. Probably sales began soon after the latter date. A number of Ideal tools are illustrated in the 1888 Marlin catalog, but according to John Amber in Ten Rare Gun Catalogs, the first Ideal Hand Book did not appear until 1892. Amber's book contains a reproduction of this first handbook. It and later hand books furnish much information of value in identifying the different models and their purposes. Since there is no readily discernible chronological order the Ideal line will be described numerically beginning with the number one model. These will be followed by the other items, most of which do not have a number designation.

The Ideal Number One tool was of tong type with bullet

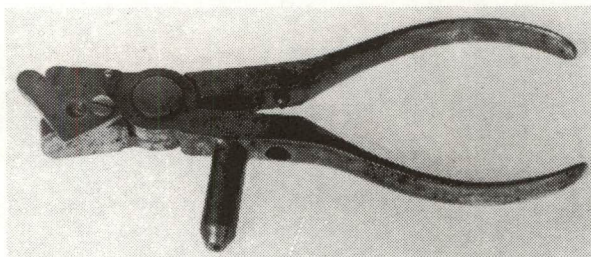

A

mold as seen in (A). Cases were decapped by being forced over a pin which was placed in the chamber. There was a shoulder on the later pins which belled the case mouth slightly for easier loading. After decapping, the case was recapped and the assembled cartridge placed in the chamber where the bullet was seated and crimped into place. The catalog pointed out that no bullet sizer was provided on this model, since many of the bullets were of the "heel" type and not intended to be sized. This tool was made for pistol and small rifle cartridges. Nickel plate was the finish used on all early Ideal tools.

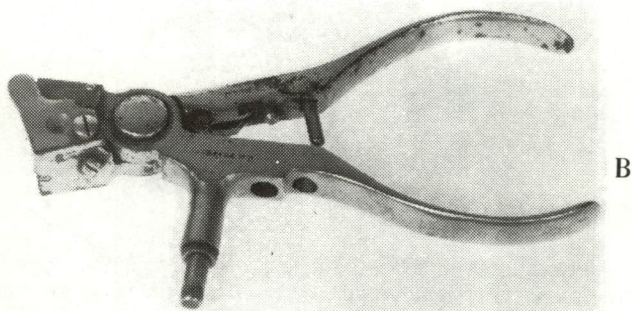

The Number Two (B) was a specialized tool designed for the Smith and Wesson target cartridges. It is distinguished by a plunger on the chamber which could be adjusted to seat bullets to different depths, depending on the powder charge. There was a bullet sizer in the lower handle. The capper was located either there or on the end of the mold block. It appears to have been made for only the .32-44 and .38-44 cartridges and the special .32 Smith and Wesson rifle cartridge, and is one of the scarcest of the Ideal line. The April 26, 1888, issue of Forest and Stream carries an advertisement for this particular tool.

The Number Three is referred to as "Special," probably because it could be furnished with either single or double adjustable chamber and muzzle (mouth) resizer. It was available in the whole range of calibers from .22-15-60 Stevens to the .50-100-450. There was no mold. The

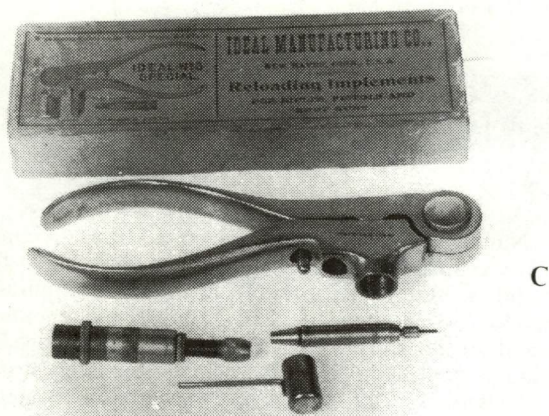

Number Three Special tool shown in (C) with accessories and box has the double adjustable chamber and is .38-55

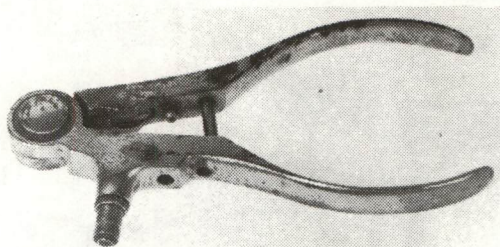

D

caliber. Shown in (D) is a single adjustable chamber type in the scarce .22-10 Maynard caliber. This is the smallest of all American centerfire cartridges and held from 7 to 10 grains of powder behind a 45 grain bullet.

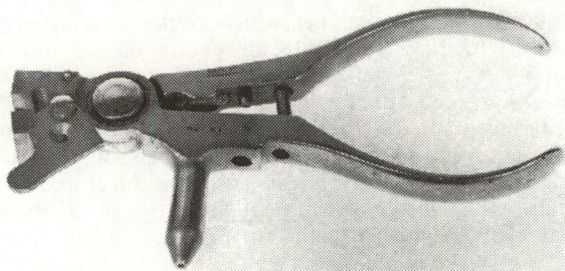

E

The Number Four (E) was similar to the Number One but differed from it primarily in the addition of a bullet sizer. It was available for a similar range of pistol and small rifle cartridges. At one time it was made with detachable mold blocks like those on the regular Ideal mold.

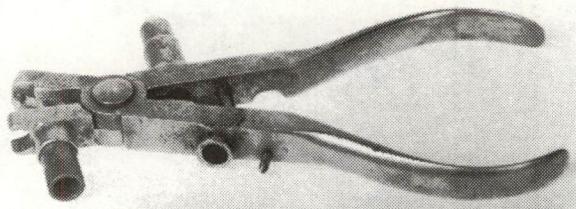

F

Ideal's Number Five (F) was designated the "Army Tool." It was made specifically for military shooting of the period and was therefore produced in the current military caliber, .45-70. On the end of the tool is a case mouth resizer and a capper. The seating chamber is non-adjustable but a double adjustable one was available separately which could be used in place of the case mouth sizer. Catalog illustrations show the tool without a chisel-type Berdan decapper but the specimen here pictured has one. This model was manufactured for only a few years and is quite

scarce. The writer has seen one in .40-60 Marlin caliber, which illustrates the kind of variations to be found in the Ideal tools.

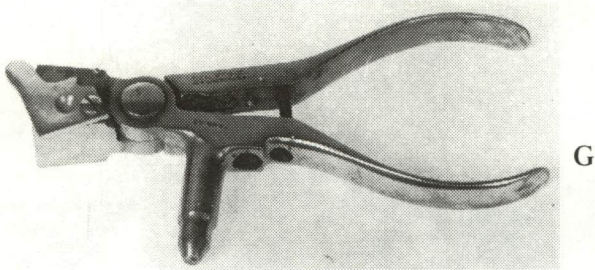

The Number Six tool was one of the most popular in the Ideal line (G). It was the large-size counterpart of the Number Four and was produced for a great number of calibers from .25-35 to .50-100-450. A bullet mold was located on the end as on the numbers One and Four. Toward the end of production some of these had the detachable mold blocks found on regular Ideal molds. The Number Six could be purchased with either fixed or adjustable chamber but according to the early catalogs all tools for cartridges over 2½ inches in length would have the adjustable chambers. A variation on this model produced for Stevens and so marked is discussed in the Maynard and Stevens section.

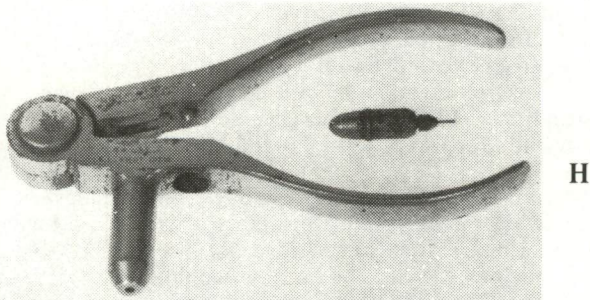

Rarely seen is the Ideal Number Seven tool (H). This very specialized item was apparently available for only a few years and for only one caliber, the .44 X.L. shot cartridge. The cartridge is the same as the .44-40 Winchester but loaded with shot in a special container that projected out of the mouth like a bullet. It was used to some extent by taxidermists and in shooting pests. The only functions performed by the tool are decapping, recapping, and the

seating of the special case full of shot. This is probably the scarcest of all the Ideal tools.

Not nearly so rare but still not common is the Number

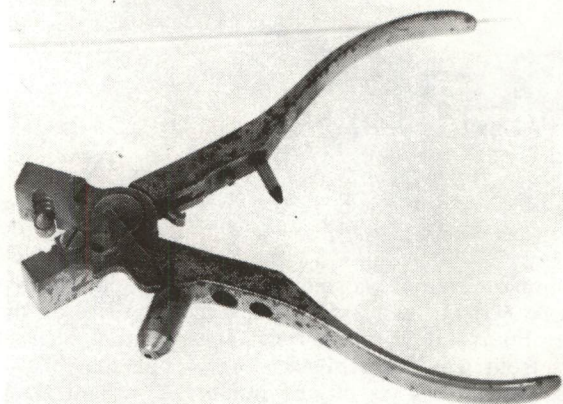

Eight (I). The distinguishing features of this tool are the hollow base bullet mold and pointed bullet sizer plunger.

Most early centerfire cartridges used bullets like those on most of the rimfires: The bullet was the same diameter as the cartridge case. It was held in the case by a base or "heel" having a reduced diameter to fit the case mouth. Present day .22 rimfires are still made this way, although the old .22 WRF and .25 Stevens rimfires and some others were not. These heel bullets had to be lubricated by putting grease in grooves on the exposed part of the bullet. They were also known as "outside lubricated" and the designation "O.L." is sometimes seen. Such bullets were messy and prone to pick up lint and other matter.

Inside lubrication, using grease grooves on the sides of the bullet which were covered by the case neck when loaded, offered a much superior cartridge. But a bullet that would fit down into the heel bullet case would be undersize for the bore and would not take the rifling. The solution was a cartridge having a longer case to cover the lubricant grooves on a bullet entirely of "heel" diameter. A deep hollow base similar to that on the Civil War "minie ball" provided for expansion of the bullet to fill the bore when the cartridge was fired.

The Number Eight tool was developed to load this inside lubricated (I.L.) ammunition. The mold had a plug which



produced the base cavity and which moved slightly to allow the bullet to drop out. This hollow base necessitated a pointed bullet sizing plunger.

At first the Number Eight tool was made only for the .38 long, to be used in the then new Colt military revolver although the bullet was also recommended for the .38 extra long Ballard and other rifles. Later it was made for similar cartridges, such as the .32 long and .41 long. When outside lubricated bullets were to be used the Number One tool was recommended.

With the coming of rimless cartridges a new tool, the Number Ten Special, was brought out. It incorporated a "priming hook," later supplanted by a sliding plate, which engaged the groove in the cartridge base and held it during the capping operation. Eventually this and the Number Three Special were combined in and replaced by the 310 tool which is currently manufactured.

This listing completes the line of Ideal numbered tools so far as the writer has been able to learn. However, a complete set of Ideal Hand books was not available and it is possible that some tool has been missed.

Minor variations are encountered, such as the placement of the capper and the absence or presence of a Berdan decapping chisel, but a detailed listing of all of these would be more confusing than helpful.

A simple reference chart has been prepared to make immediate identification convenient:

Number	Distinguishing Features	Mold
One	non-adjustable; no bullet sizer	Yes
Two	for S & W target cartridges; adjustable seater, no crimper	Yes
Three	single or double adjustable chamber	No
Four	smaller cartridges; bullet sizer	Yes
Five	case mouth sizer and capper on end	No
Six	for large cartridges, sizer	Yes
Seven	.44 X.L. shot only, no sizer	No
Eight	hollow base bullet; pointed plunger	Yes
Ten	"priming hook" or plate	No

In addition to the usual wood handled bullet molds commonly seen, Ideal offered other specialized types of molds.

For the shooter wanting to be able to use a variety of bullet weights there were adjustable molds. One of these, patented February 10, 1891, and advertised in the March 19th issue of Forest and Stream, was like the conventional Ideal mold except that bullets were poured from the tip and the base was adjustable up and down to vary the weight. A depression in the base of the bullet served both to promote expansion and as a place for the "tail" or twisted part of a paper patch (Sharps molds produced a similar depression). A lock nut keeps the plunger from losing its adjustment. This mold was first made for patched bullets only, but it was soon abandoned in favor of another type. However, the design was used for the "Perfection" mold for grooved

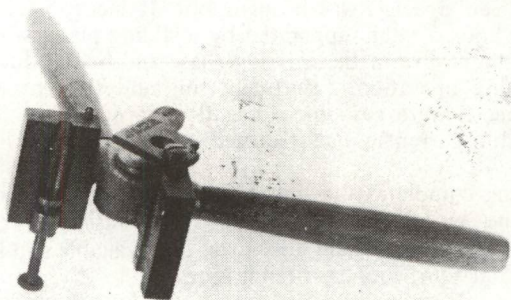

J

bullets shown in (J). The Ideal Hand Books available show this mold made for bullets from .25 to .45 caliber, but the writer once owned one in .22 caliber.

One interesting bullet for which this mold was made is the .45 S (Sharps), which had a diameter of .451 and was apparently really designed for the .44 Sharps cartridges. It shoots well in the writer's .44-77 Sharps caliber Remington.

Replacing this kind of mold for the making of patched bullets was the Ideal Cylindrical Adjustable Mold seen in

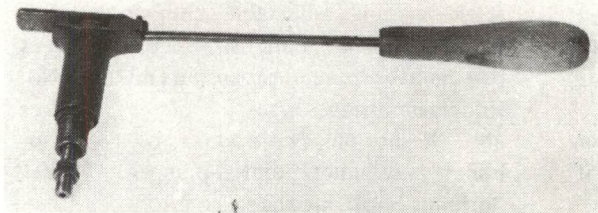

K

(K). Bullet length is adjusted by a lock-nut arrangement. Then the push-out plunger must be adjusted so that it will not strike the cutoff plate and be damaged. Ideal made a

great point of these bullets being perfectly cylindrical.

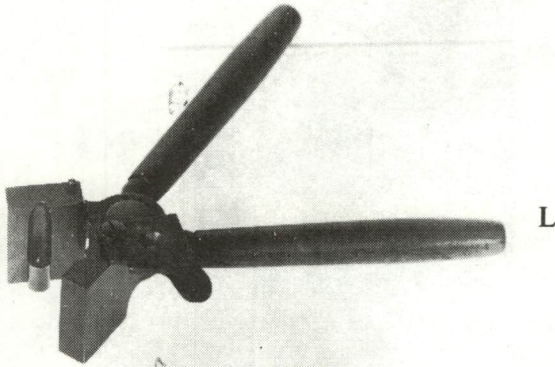

An interesting mold of the regular type is shown in (L). It is marked “.38-330 Rabbeth” on the cutoff plate. The bullet is poured from the point, thus insuring a good base. A plug is at the base end. Rabbeth was a prominent shooter at the famous Walnut Hill range near Boston and an author of shooting articles using the name J. Francis. The bullet, of his design, was made for the “Chase Patch.” The paper patch passed around the bullet only once and the edges met parallel to the bullet axis instead of there being a double thickness of paper with diagonal edges as on other patched bullets. The patch was rolled into a tube and placed in a ball seater (described below) and then the bullet placed in it and the assembled unit pushed into the chamber and on into the rifling. This method of loading produced great accuracy but, of course, was only practical for target shooting. The bullet (or “ball” as it was still called as a hold over from earlier days) was sometimes seated ahead of the cartridge case so that it would be absolutely straight in the bore and not subject to tipping or distortion. Although many of these seaters were home made, Ideal offered two

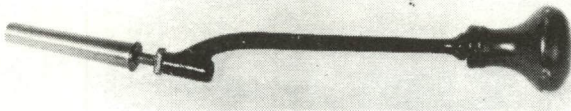

M

different models. On the one shown (M, N) bullet seating depth was adjustable. It was made in all calibers from .22 up. Later a plain but very sturdy bullet seater was listed. It was designated Number One and the adjustable one Number Two.

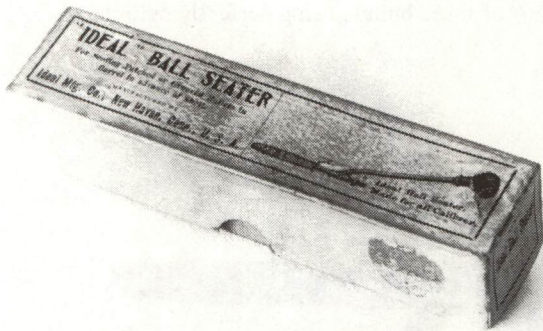

N

When shooting in this manner the cases needed only de- and recapping so tools for that purpose were available. First to appear was one similar to the Ballard tool except that different sizes of die and decapping plug would interchange, making one basic tool serve different calibers of cartridge

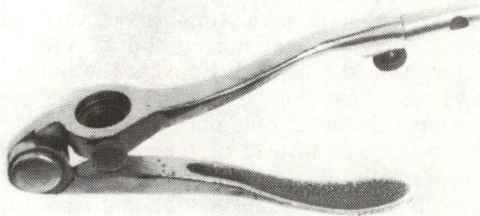

O

(O). In some the die is surrounded by the handle and in

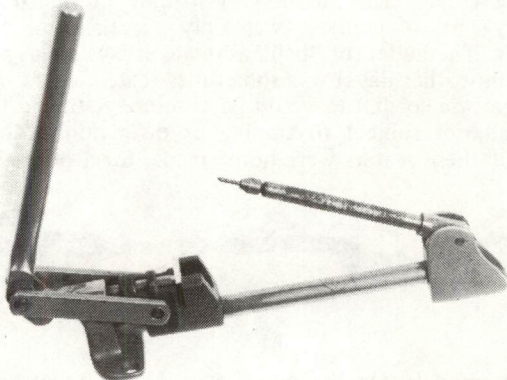

P

others half the die is exposed. With the introduction of (P) the first type was called Number One and the second type Number Two. The latter could be mounted or folded for carrying in the pocket. It featured greater power than the

Number One and the case was decapped and recapped in the same position.

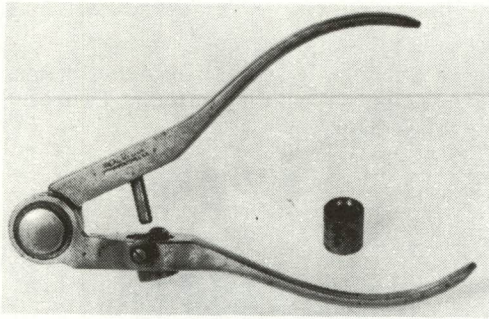

Q

A separate bullet sizer (Q) was available, using different dies that could be interchanged. Sizing diameters of the dies are stamped either on the side or the bottom of the die and sometimes both places with the nominal diameter on the bottom. The die pivoted so that plunger force was in line with its axis.

One of the most interesting of all the Ideal tools was the

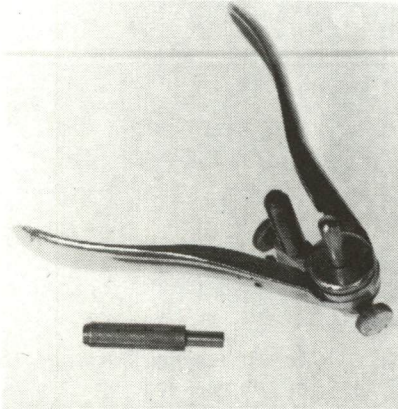

R

shell indenter (R). With black powder, the bullet was supported by the powder and it could not readily push back in the case. With the air space present in smokeless cartridges, bullet set-back was a problem, especially with tubular magazine rifles. One solution was a tight neck. Another was the indenter. With it a number of dents were made around the case neck to keep the bullet from pushing in. It was adjustable for dent location to regulate the seating depth. Additional interchangeable shell holders were

available separately. Since a regular decapping pin would not clear the dents, special grooved pins were available, one for use in regular Ideal tools and another with a wood handle for hand use.

Ideal produced a number of powder measures besides the familiar dipper supplied with their tools. Two of these measures are shown here.

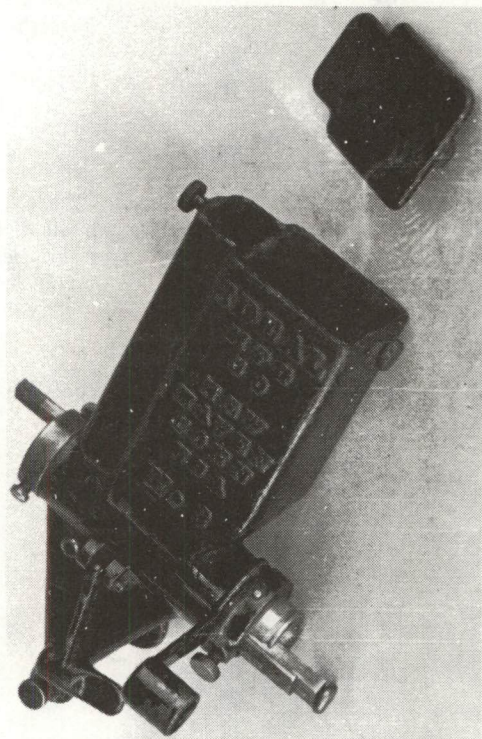

S

The Number Six Universal Powder Measure (S) was designed specifically for duplex loading. This loading technique was developed soon after smokeless powder appeared. A light charge of smokeless powder was loaded on top of the primer and the remaining powder space filled with black powder. The load thus produced shot cleaner than straight black powder yet the pressures remained relatively low and accuracy was extremely good.

For a few years Ideal produced what they called their Number Two powder measure which would load the so called "duplex load," but it was superseded by the Number

Six measure. The small chamber was for the smokeless powder and the charge could be adjusted from one to 10 grains (volume) while the larger chamber held the black powder. A drop tube, either long or short, was inserted into the bottom. Fastened to the side with a cotter pin was a slapper which, when rapped against the side of the measure, dislodged any powder that had hung up, insuring correct charges every time. The more common Number Five measure was similar but lacked the priming charge feature.

The Ideal bench type powder measures were preceded by

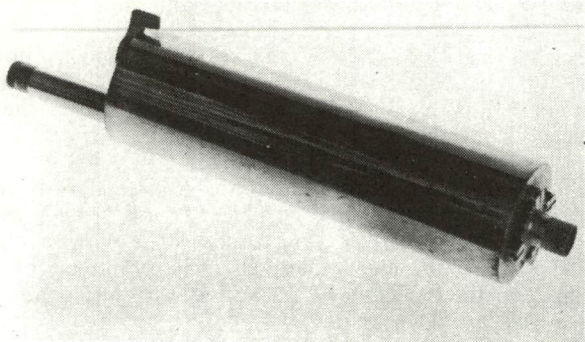

the Ideal Loading Flask (T), which was offered for only a few years. An early hand book description says "It is the only Flask in the world that can measure powder accurately for rifles, pistols, and shot guns or that has a range from 3 up to 135 grains and from  $\frac{1}{4}$  up to 5 drachms." A somewhat later description indicates its use for black or smokeless powders and provides a table of comparative black and nitro powder charges. Number one and two flasks are advertised but apparently the only difference is in the size of the "shell receiver" in which the mouth of the shell was held for charging. The finish was nickel, standard for all Ideal items except iron powder measures such as numbers five and six.

Adjustment of the powder charge was by moving a long cup in or out from the end of the flask. This cup was graduated along the side in grains and drams. It read two ways, with the closed end in for smaller charges and with the open end pointed inward for a larger powder compartment. A partial turn caused a tight friction fit. The cup, which had knurled ends for better grasping, was removed for filling the flask.

To operate, the flask was held with the powder chamber

down and powder filled it. Then a lever, like that on typical muzzle loader flasks, was pressed sideways, causing the powder charge to move into alignment with a tube passing diagonally through the flask. The shell mouth was placed into the tapered mouth of the "shell receiver" and the flask turned over so that the charge could drop through the tube and into the shell. This drop aided in properly settling the charge in the case and thus prevented the charge from being crushed in the bullet seating operation. With the charge in the shell, the "shell receiver" was turned causing it to rattle in its housing and thus shake out any grains of powder that might be hung up in the tube.

These flasks are quite scarce and are in demand by both collectors of early tools and flask collectors. The fine workmanship and interesting operation make them especially appealing.

The Ideal line was and continues to be a standard in the field. More complex and efficient tools have been developed, but the Ideal tong tool, in the form of the Model 310 and the Ideal mold, with a cherry number often dating into the last century, are still with us and continue to see widespread use.



## MISCELLANEOUS TOOLS

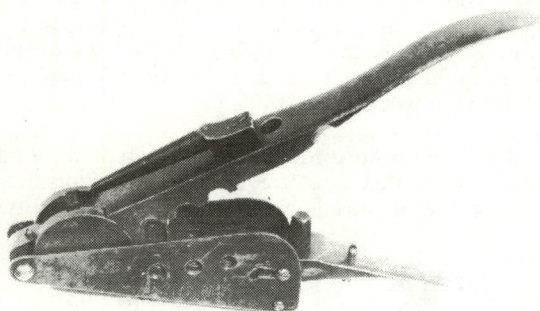

Chadron, Nebraska is the origin of the intricate tool shown in (A). The firm of Lyon and Boyd manufactured these under patents of March 1, 1887 and February 21, 1888. They are apparently quite rare, the writer having seen only two. The one illustrated is .40-90 bottleneck caliber and the other one is .22 WCF. Three bullets, two of one weight and one longer and heavier, can be cast at one time. Opening the handles causes the plate to shear off the sprues. After lubricating, the bullets are pushed through the die in one handle by a fixed plunger in the other. Cases can be decapped with either the rod on the side of the handle or, in the case of Berdan primers, with the adjustable chisel. Capping is accomplished at the hinge as on the Marlin tool. After charging the case with powder and putting the bullet in place, the seating is done in a chamber in one handle.

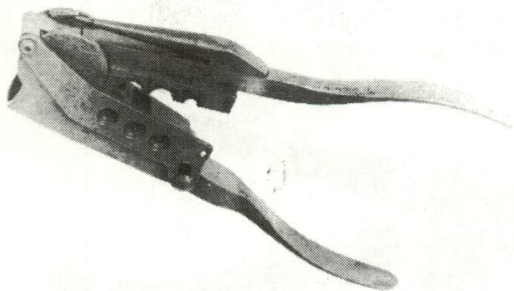

“J.W. Boyd” is the only marking on this tool (B) which is obviously related to the previously described one. Presumably it is the same Boyd. The “filed out” appearance of this tool suggests that it preceded the other but there is no real evidence as to which was earlier. It casts three

thirty-eight caliber bullets, one long, one short, and one round and differs from the previous tool in the absence of the Berdan chisel and sizer, and in seating from the hinge end. Dr. Stephen Chilian, from whom it was acquired, obtained it from an old gentleman who claimed Boyd had a gunsmith shop in Washington, D.C., where he made up these tools in various calibers.

Some loading tools were produced in the far West. While this region is associated most frequently with big game, it was also the scene of considerable target shooting. The two



re-decappers in (C) were the kind frequently used by Schuetzen shooters who needed a tool only to decap and recap, often right at the range. These are almost identical, though made by different gunsmiths. On the left is one marked "A.O. Bremer, maker" on one handle and "S.F. Cal" on the other. The handles are brass. Bremer also made duplex powder measures and swaged bullets. Also of brass but nickel plated is the second one, made by J. Gruhler of Sacramento.

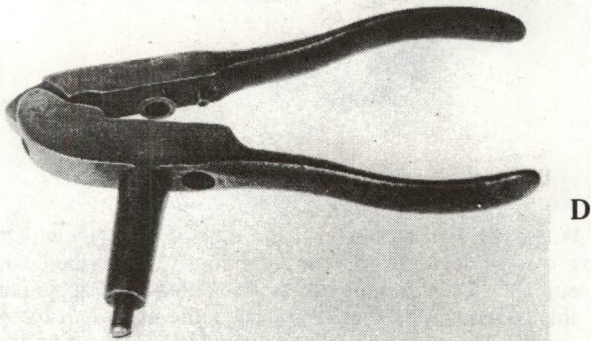

Another California producer of loading tools was C.D. Ladd who worked in San Francisco in the 1870s. Note the similarity of (D) to the common Winchester tong tool. These tools were painted gold. The crimped cartridge was pushed out with a plunger. Ladd molds are shown elsewhere.

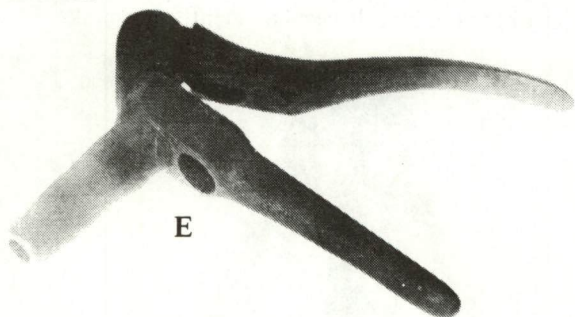

E

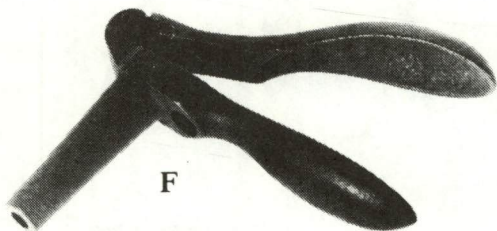

F

The very crude and simple tools shown in (E) and (F) are unidentified. The first of these came with a mold of the type found in a boxed set of C.D. Ladd tools, raising a question as to whether they might not be Ladd tools also, or that Ladd's tools and these had a common supplier. They are rough cast or forged like the early Winchester tools and painted gold.

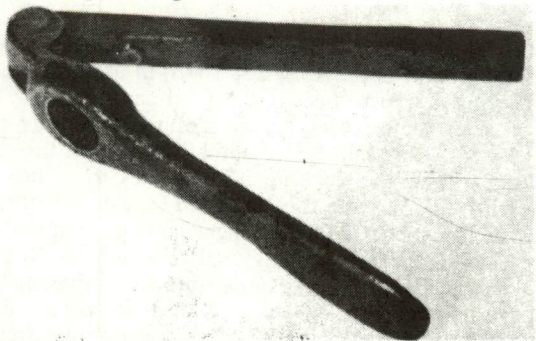

G

(G) is a rough gold-painted capper. The round handle

appears cut off and may have had a decapping pin like that on the Ballard tool, or it may have been a wad seater. It is unidentified.

One of the great barrel makers of the single shot rifle period was A. W. Peterson of Denver, Colorado. This re-decapper (H) is attributed to him. It bears no identifying marks.

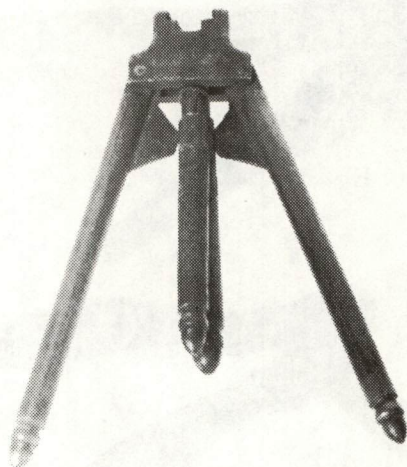

H

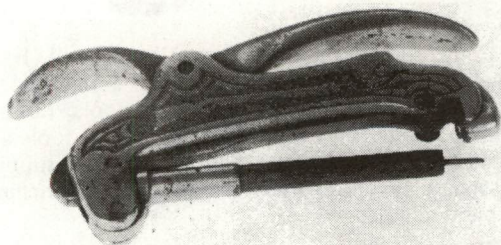

I

The novel Kingsland re-decapper (I) has a rifle cast in one side and the patent date, April 23, 1878, in the other. The mandrel swings aside to accept the fired case. Pressure on the short lever then causes the de-capping pin inside the mandrel to push through the flash hole forcing out the cap. At the same time the capping piece moves so as not to interfere with the movement of the fired cap. A new primer is placed in the pocket and the longer lever pressed seating the primer. A variation of this tool reported by Robert Ernst of Barrie, Ontario, has a more rounded body which is painted gold, with nicked levers. It has the patent date cast on the body and "40," the caliber, on the mandrel or stem.

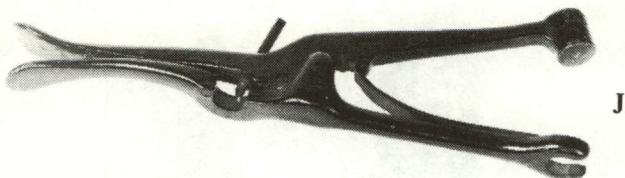

The druggist from whom (J) was purchased remarked that it looked like some kind of obstetrical instrument to him. It has a Berdan decapping chisel and a broad capping surface unlike that on any other tools observed. It does not work very well, which perhaps helps to account for its rarity. The writer has, however, seen a total of three of them. It is unidentified. The finish is black paint.

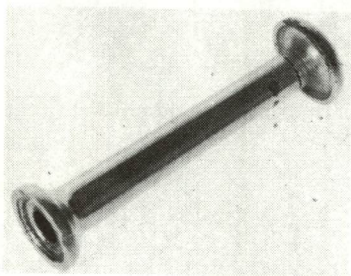

There is a great similarity between this unidentified bullet seater (K) and the Ballard seater. It is carefully made and nickeled. There is no groove in the bottom to aid in extracting the loaded cartridge. Instead, the base has a kind of counterbore which allows room for a knife point or other device to pry out the cartridge.

John T. Amber's Ten Rare Gun Catalogs contains a reproduction of the Whitney Arms Company catalog of about 1878 which illustrates their loading tools and mold. The first item shown in (L) appears to be a Whitney bullet seater, or at least most of one since the catalog illustration shows a somewhat ball shaped handle on the top. The only markings are "50 70 G" with the "G" no doubt referring to the government cartridge, though it could mean grains of powder, or grooved bullet.

Beside it is an unidentified one-piece device presumed to be a bullet seater though it would seem to lack the broad handle or other top surface to facilitate the downward push necessary in bullet seating. However, it is stamped in the base "45" and accepts the .45-70 cartridge. The cut

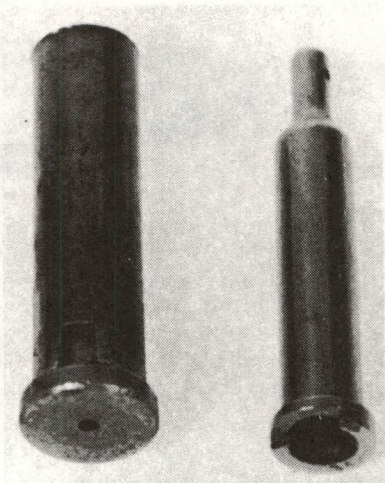

L

away portion of the base would allow for extraction of a loaded cartridge.

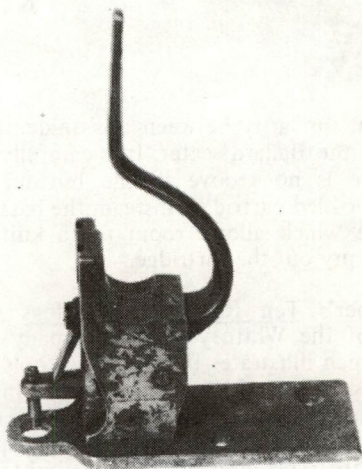

M

The tool shown in (M) appears to be a bench mounted capper. As with so many other items of the "gilded age," it too has a gold paint finish. The primer seating depth is adjustable. Cases with head dimensions of the .45-70 fit nicely. When the lever, which looks strikingly like a trigger guard, is raised, the primer seater moves over the hole and downward. There are no markings on it.

Among the rarest of loading tools are those by Providence Tool Company for their Peabody-Martini rifles. Capper, decapper, and bullet seater are illustrated in James Grant's Single Shot Rifles wherein the loading tool page from the 1881 Providence Tool Company catalog is reproduced. More Single Shot Rifles shows the actual tools. The Capper

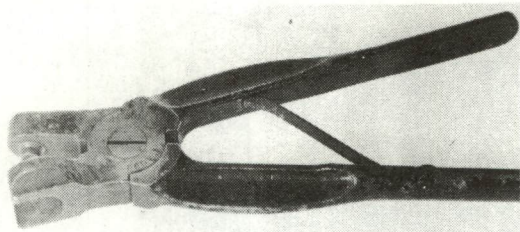

N

in (N) bears the Providence Tool Company name. It is well made with black Japanned handles. The caliber, .50, is stamped inside the jaws. Their Berdan decapper is shown in

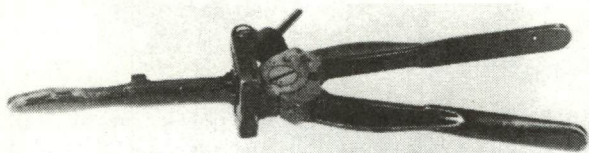

O

(O). It bears only the caliber marking “.45” stamped on the hinge. As with the capper, the handles are Japanned black. To operate it, the case is placed in a kind of cradle on the projecting arm, the handles are closed causing the chisel to pierce the primer, and the arm is then raised, pulling out the primer.

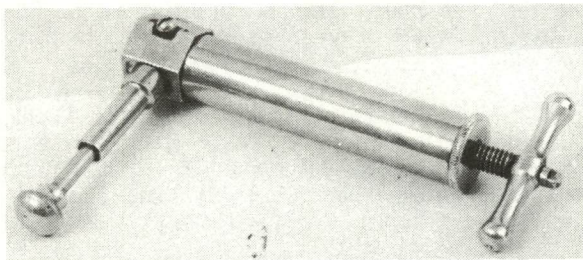

P

The identification of (P) was by means of an illustration in A.C. Gould's Modern American Rifles, a book first published in 1892 and then republished by Samworth in 1946. It is a Harwood bullet lubricating pump. Such a

device was very useful for fast, clean, and thorough lubricating of greased bullets. The lubricant was forced into the grooves under pressure. Then the bullet was pushed out of the holder by the knurled push rod.

George Schoyen, the noted Denver barrel maker, is

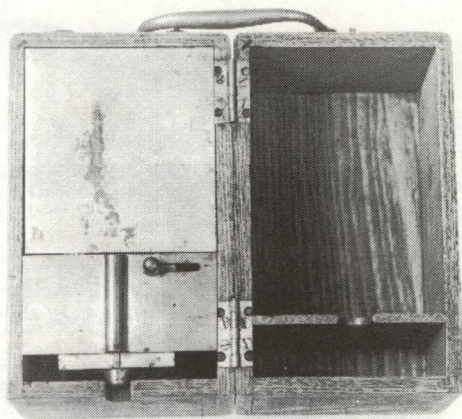

reportedly the maker of this duplex powder measure (Q). (Duplex loading is discussed in the Ideal chapter.) This measure is contained in an oak box which fastens shut by means of a screw on the brass carrying handle. There is room in the box for cases, bullets, primers, and capper, so that a compact outfit could be taken to the shooting range. The black powder charge is adjusted by a screw near the spout. With a case at the spout, the small round handle is pushed to one side and then to the other. The first movement drops the smokeless primer charge and the second the main charge. The powder reservoirs are filled from the top where they are closed by neatly turned wooden plugs.

A most rare and unusual outfit is that used for reloading the Burnside cartridge and shown in (R). It is in the collection of J. Howard Baker and was brought to the writer's attention by Lee K. Boddy. The photo and information were supplied by Harry Hansen.

On the right are the two pieces of what is apparently a bullet swage for forming the bullet from either cut lead rod or a cast slug. The largest item is the body of a bullet seater and to its right is the cap. The assembled cartridge is placed in the body and the cap forced down on it to make the



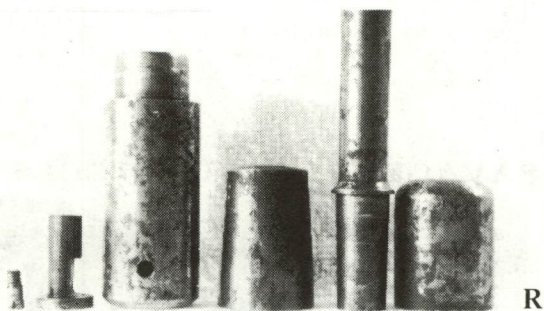

crimp. On the left are the pushout plunger and its retaining screw.

Although somewhat modern, the remaining four tools are

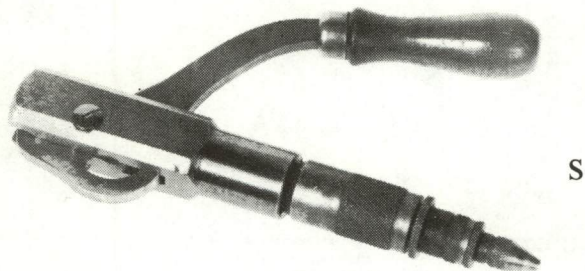

included because they are of collector interest. (S) shows the Savage loading tool. The instruction sheet reproduced here (T) is an aid to better understanding its operation. Note that it was furnished only in the five different calibers available in the early Savage rifles. The finish is blue with color case hardened lever. The other loading items appear to be from the Ideal line rather than of Savage's own design and manufacture.

In a Newton Arms Company catalog appears this statement by way of introducing their tool: "We have long felt that the American Shooter was entitled to something better than a nickel plated pair of malleable iron tongs with which to load the ammunition for his rifle and the accompanying drawing shows our first attempt at providing something better." This beautifully-made, compact tool is shown with

## SAVAGE RELOADING TOOLS.

**Tool Complete** (without midget cap extractor and charge cup included). **\$3.00**

**Price, Die only. \$2.00.**

- "A" Shell Die
- "B" Crimper
- "C" Crimper Ring
- "D" Bullet Seater
- "E" Bullet Seater Ring
- "F" Body
- "G" Lever
- "H" Rescaper.

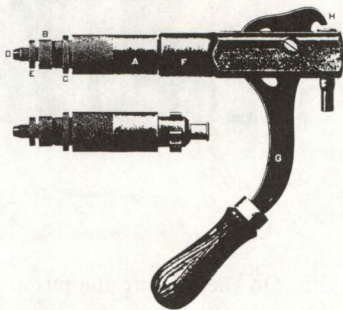

### Instructions for Reloading of Cartridges.

Insert the primed primer by placing the cap extractor in the die "A". See that the bullet seater "D" is adjusted at the proper depth, and loaded with the ring "E". Insert the shell die "A" into the body "F", turn to the right and the die becomes locked. Take care that the point of the cap extractor is fitted into the primer hole of the empty shell. Then press on the lever sufficiently to remove the primer.

To resize if necessary, wipe shell over with a slightly oiled cloth and place in the "A". Repeat the die in tool as above described and operate lever "G". The powder charge enters the ring inside the body "F" DIRECTLY on the head of the shell, thus forcing it into the die and resizing the shell so that it will readily chamber in the rifle barrel. This operation is done with ONE MOVEMENT of the lever and the fact that the die "A" containing the shell can be instantly placed in position allows of the most **rapid and satisfying results.** There is no tedious slow screw movements to operate. The backward movement of the lever extracts the shell from the die.

To recap, start the new primer in its place, place the shell in position "H" and press home with the lever. Care should be taken that the primer is seated at its correct depth.

To load a cartridge, charge shell with powder, seat bullet in mouth of shell and place the cartridge in the "A". Adjust crimper "B" to crimp or not to crimp as desired, and back same with its ring "C". Adjust bullet seater to the right length lacking same with ring "E". After pressing bullet home reverse lever, remove die and the cartridge will drop out. The end of bullet seater "D" is beveled and can be used to open mouths of shells if required. Any variety of bullet may be used and the same seated by proper adjustment.

#### CAUTION!

Never let the "A" accumulate dirt or rust, keep slightly oiled. Do not experiment with powder charges, especially high pressure smokeless.

Do not let shells corrode, to successfully reload these should be perfectly clean both inside and outside.

When resizing do not attempt to reload with light and powder charge on a previous.

Miss-fires are apt to occur if the primer is not properly seated.

Do not mutilate the base of a bullet by forcing it into the primed mouth of a shell.

To properly prepare ammunition and secure accurate results, attention must be right, therefore go at the matter intelligently.

**The completeness of each tool and the rapidity of manipulation are the great advantages of the Savage Reloader.**

#### SPECIAL NOTICE!

This is the only tool that is adjustable **without extra parts** to remove exploded primer, reduce the shell and reload each and every cartridge for which it is made. Each tool complete in itself. Target shooters and hunters will appreciate this reloader as it permits of their experimenting in the different loads and varieties of bullets.

**Can be furnished in the following calibers: .303, 30-30, 25-35, 32-40 and 38-55.**

### Savage Molds, Charge Cups, Etc.



T



its cardboard tube in (U). Directions for use are printed on the outside of the tube, which has a screw top and metal bottom. Capping is accomplished in the recess in the base. The finish is blue with color case hardened link. There are no markings on the tool.

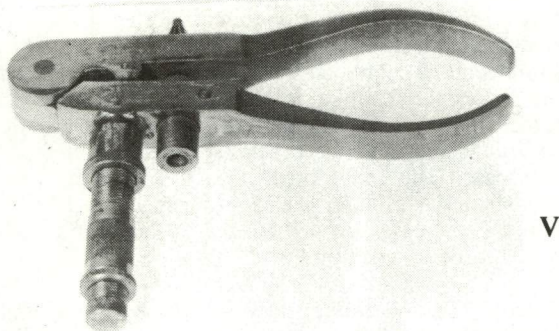

The massive bronze tong tool in (V) is a product of Modern Bond. Among its interesting features are the straight line bullet sizer behind the seating die, and the tapered reamer for chamfering case mouths for easier loading.

Frankford Arsenal once produced various loading accessories as an inducement to military units to reload ammunition. The elaborate kit shown in (W) is essentially just a decapping outfit. Accompanying it is a numbered instructional manual printed in 1917 but making reference to earlier editions beginning in 1907, thus dating the outfit. It was made primarily to decap the .30-'06 cartridge but was also suitable for the .30-40 and the .38 revolver cases and, with an adapter, to the .45 automatic and revolver

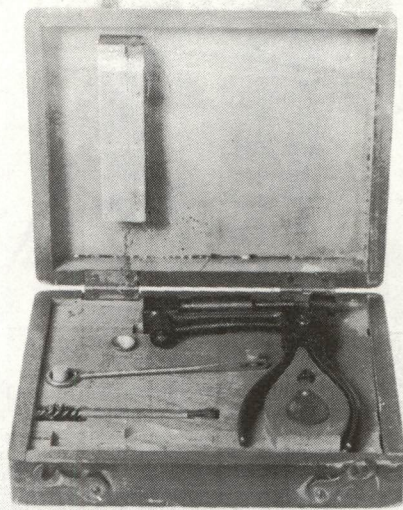

W

cartridges. In the thorough government style of the time it is boxed in an inletted hardwood case. A case is placed over the spindle and the handles closed forcing out the fired primer. Then the spindle is swung aside and the case removed. The small funnel is placed in the case mouth to reduce bristle wear and the brush used with water to wash out the case. The small brush was used on the primer pocket. Then the miniature cleaning rod was used with a cloth to dry the cases. An earlier government hand loading outfit was made for loading the .45-70.

In addition to the tools described here there were a number of others produced but not illustrated nor even seen by the writer except in early advertising. Bullard and U.S. Cartridge Company both produced simple straight line bullet seaters and the former also advertised an intricate-appearing tong tool. And, just a few days prior to this writing, a tong tool like the second type of Winchester but with a rod push-out instead of the extractor was examined. It bore no identification but was probably simply a convenient copy of the Winchester tool. Doubtless there were several other tools produced on a small scale by various gunsmiths and inventors awaiting discovery and identification.

## MISCELLANEOUS MOLDS

California had its share of gunmakers in both the percussion and cartridge periods. One of these was the San Francisco firm of Liddle and Kaeding, which sold a variety of arms, including a single shot rifle of their own design. They also

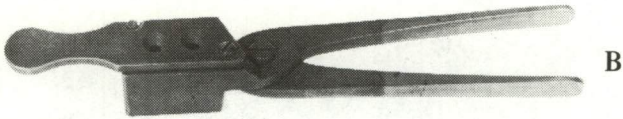

produced the molds shown in (A) and (B). Both are of brass with steel cut-off plate and bear only the maker's name stamped on the handle. Except that one is of greater size and has two cavities, they are essentially the same.

C.D. Ladd was another San Francisco gun dealer who

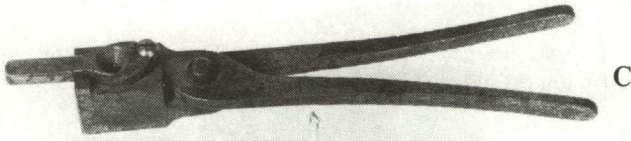

produced loading implements. (C) illustrates a Ladd mold. These may be marked "C.D. Ladd, S.F." or be unmarked. The Ladd tool is described under "Miscellaneous Tools." A similar mold but with a bulge on the side to reinforce the cut-off plate screw and a plug for making hollow base bullets is known.

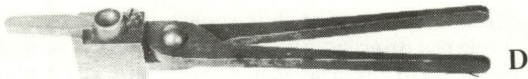

Another Ladd mold is that shown in (D); this mold is illustrated on the label of a box of Ladd tools.



E

Although rather crude in appearance (E) appears to be some kind of regularly manufactured product. It bears no identification. Note the similarity to the Winchester iron handled mold: This is not to suggest that Winchester made it, however.

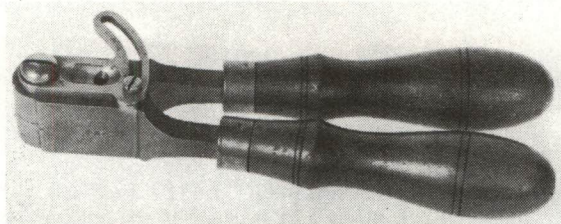

F

In contrast to the crudeness of (E) is this handsome and carefully made brass mold (F). The only marking on it is the caliber, .45-75. Note the unusual design of the sprue cutter. It bears a certain resemblance to the Farrow mold illustrated in the 1962 Gun Digest, but there are several differences, and it remains unidentified.

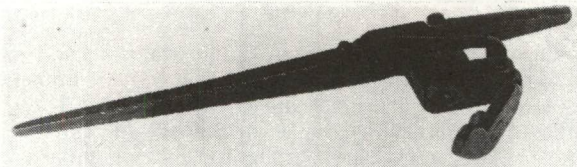

G

Another unidentified mold is shown in (G). It is of iron with a sprue cutter on the top and a hinged hollow base plug on the bottom. The tang is made to fit into a wooden handle for cooler bullet casting. This mold was in an old shooting kit with a Ladd mold, Ballard re-de-capper, and a supply of .40-90 Ideal everlasting cartridges. It is probably not a production item. There are no markings.

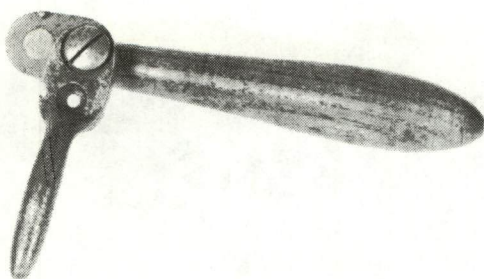

H

Still another unidentified mold is (H). It is of brass with an iron cut-off. The only marking is "42 cal" on the base. The bullet is smooth and could be for paper patching or might be for use in some kind of late muzzle-loading rifle. F. Wesson reportedly made a .42 caliber single shot and this mold could be for that cartridge. In design it is very similar to the Starr revolver mold.

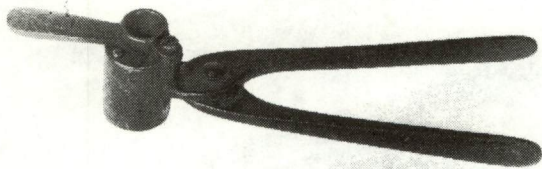

I

The Whitney Arms Company .45 caliber paper patch mold in (I) was identified through the reproduced Whitney catalog in Amber's Ten Rare Gun Catalogs. It bears no markings. The finish is black.

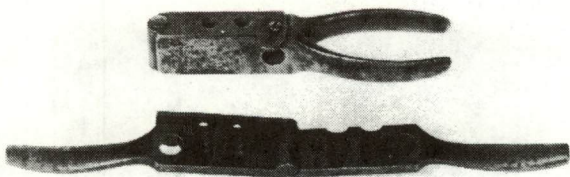

J

No markings appear on (J) but it has been tentatively identified as an Evans mold for the Evans repeating rifle. In addition to the two cavities there is a capper. Two sizes of this mold-capper are known and they are shown here. The size difference is relatively small.

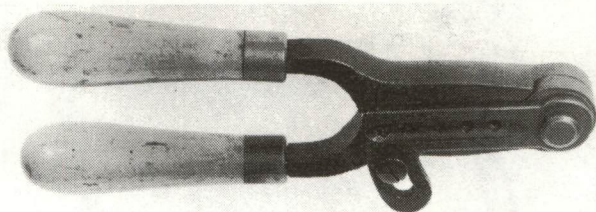

K

At one time Frankford Arsenal produced a number of loading tools and molds. In the latter category is (K). It casts five .30 caliber round balls. The block-part is brass and the cut-off blued steel. On the bottom is "Frankford Arsenal 1904 Cal. .30" and the inspector's initials. These molds are also seen in .45 caliber round ball. In each case the use was apparently for gallery loads.

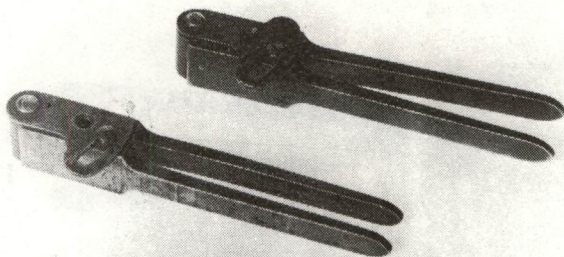

L

The two little molds in (L) are unmarked and unidentified. They are identical except for a slight difference in the sprue cutter. Both cast bullets of pistol or small rifle size, one a .385 bullet with a hemispherical nose, the other about .44 caliber. Note the similarity to the Remington pistol mold.

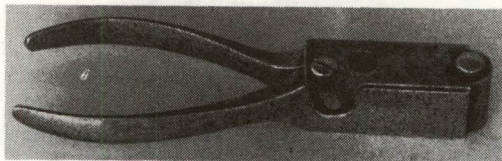

M

The mold in (M) is also unidentified. The only markings are "No. 38" referring to the caliber, and "5" inside each block. The former is the caliber. It casts a pointed bullet of the heel type. In design it is quite similar to molds furnished with cap and ball revolvers.



J. H. BARLOW.  
CARTRIDGE IMPLEMENT.

No. 309,681.

Patented Dec. 23, 1884.

Fig. 2



Fig. 1

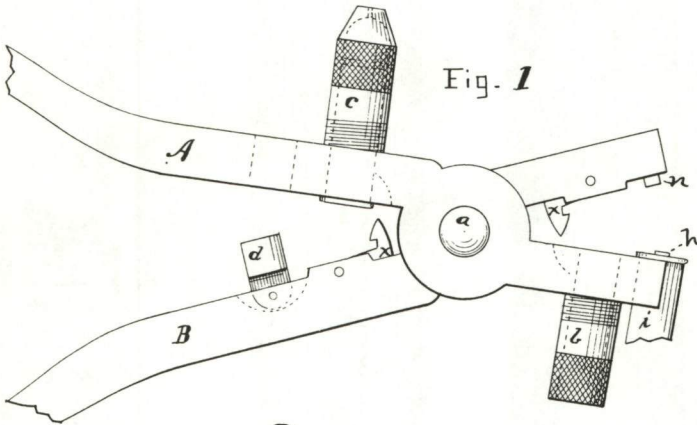

Fig. 3



WITNESSES:

*George R. Coolidge*  
*Robert L. Hazard*

INVENTOR

*John H. Barlow*

BY

*L. S. Day*  
ATTORNEY

F. J. RABBETH.  
POWDER FLASK.

No. 404,932.

Patented June 11, 1889.

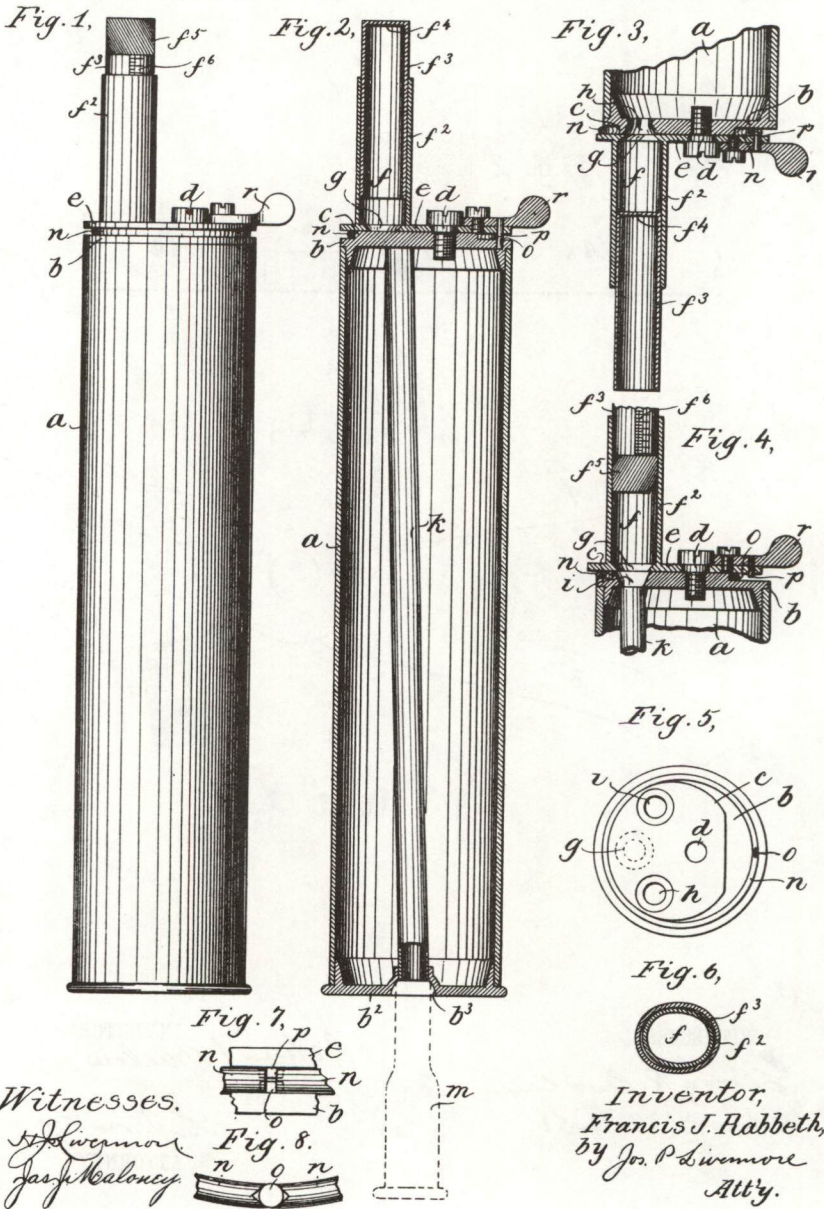

Witnesses.

J. Swannor  
Jas. J. Maloney

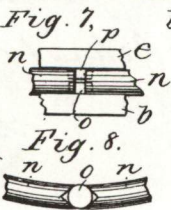

Inventor,  
Francis J. Rabbeth,  
by J. P. Swannor  
Att'y.

J. H. BARLOW.  
BULLET MOLD.

No. 446,178.

Patented Feb. 10, 1891.

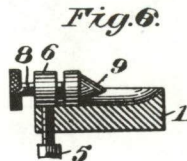
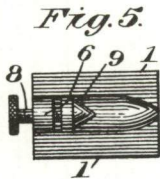
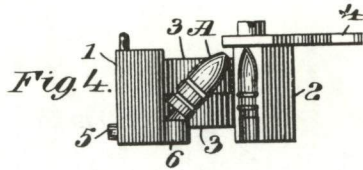
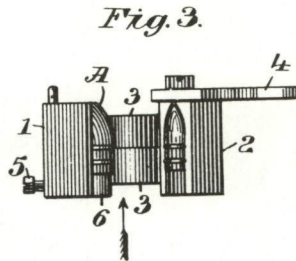
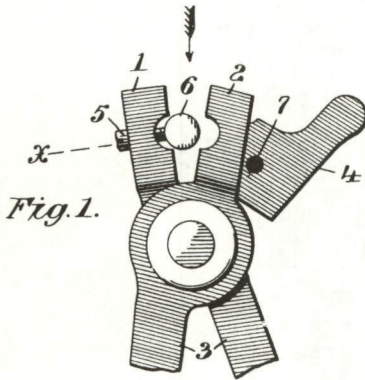
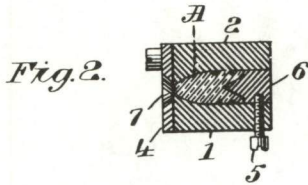

Witnesses  
A. J. Tanner.  
W. J. Tanner

Inventor  
John H. Barlow  
by his attorney  
J. A. Hubbard

J. H. BARLOW.  
BULLET SIZER.

No. 464,311.

Patented Dec. 1, 1891.

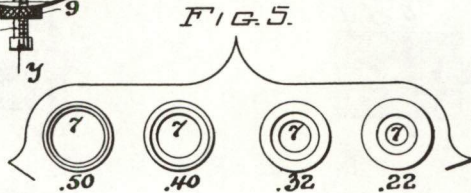
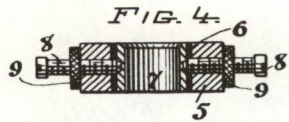
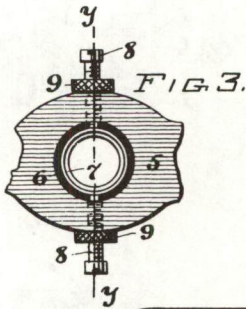
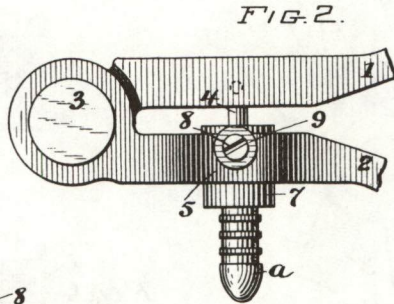
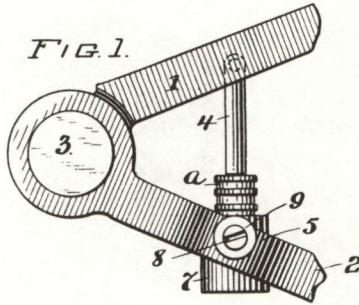

WITNESSES:  
*A. J. Tanner.*  
*E. M. Newman*

INVENTOR:  
*John H. Barlow,*  
*by his atty.*  
*D. A. Hubbard*

J. H. BARLOW.  
 DECAPPING AND RECAPPING TOOL.

No. 486,659.

Patented Nov. 22, 1892.

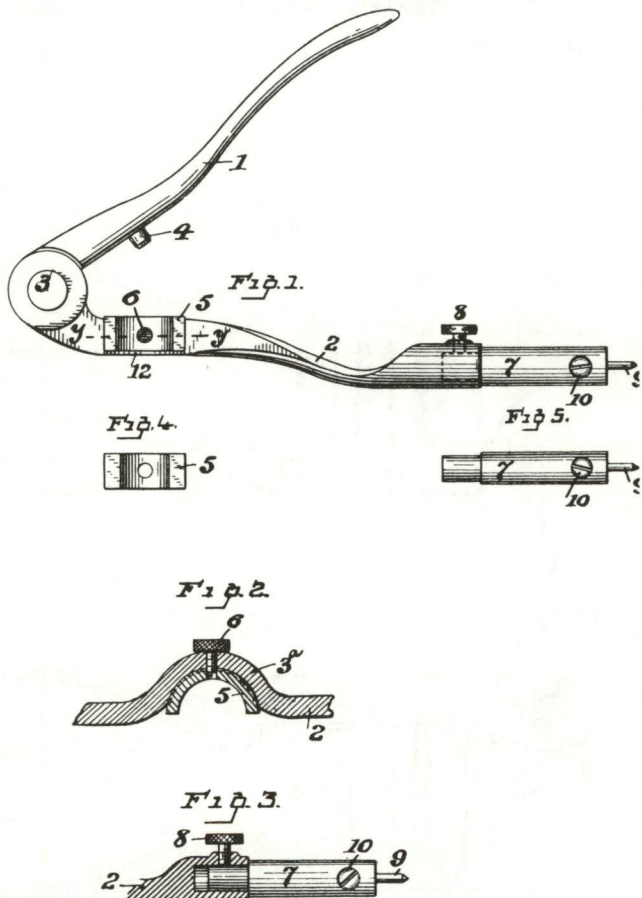

Witnesses.  
 A. J. Banner.  
 M. C. Hinchcliff.

Inventor,  
 John H. Barlow  
 by his attorney  
 O. N. Hubbard

W. W. WINCHESTER.  
Cartridge-Loading Implements.

No. 156,197.

Patented Oct. 20, 1874

Fig 1

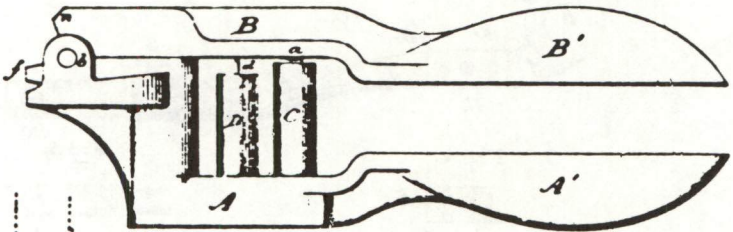
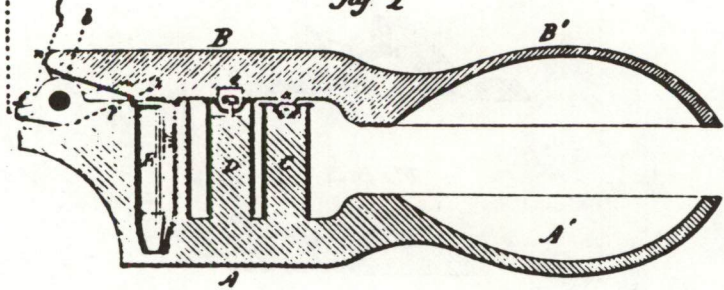

Fig 2



Witness  
A. J. Tibbitts  
J. H. Hummer

Wm. W. Winchester  
By Atty. General  
John D. Carl

(No Model.)

V. A. KING.  
Cartridge Implement.

No. 232,189.

Patented Sept. 14, 1880.

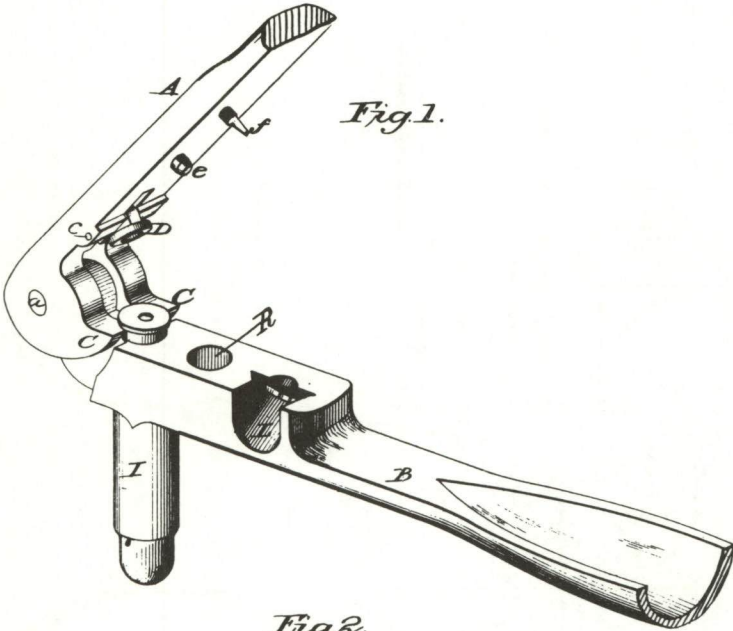

Fig. 1.

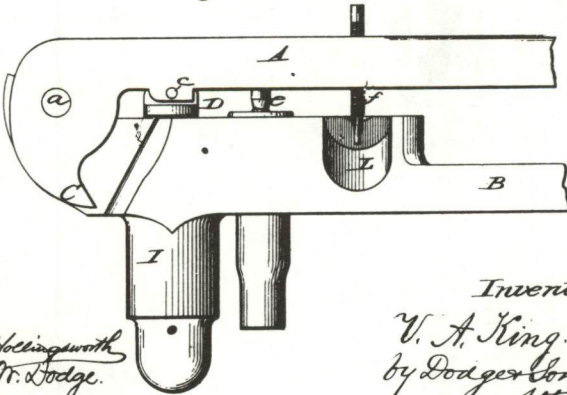

Fig. 2.

Attest.

Sidney P. Hocking with  
William W. Dodge.

Inventor.

V. A. King.  
by Dodge & Co.  
Atty.

(No Model.)

J. H. BARLOW.  
CARTRIDGE RELOADING TOOL.

No. 267,130.

Patented Nov. 7, 1882.

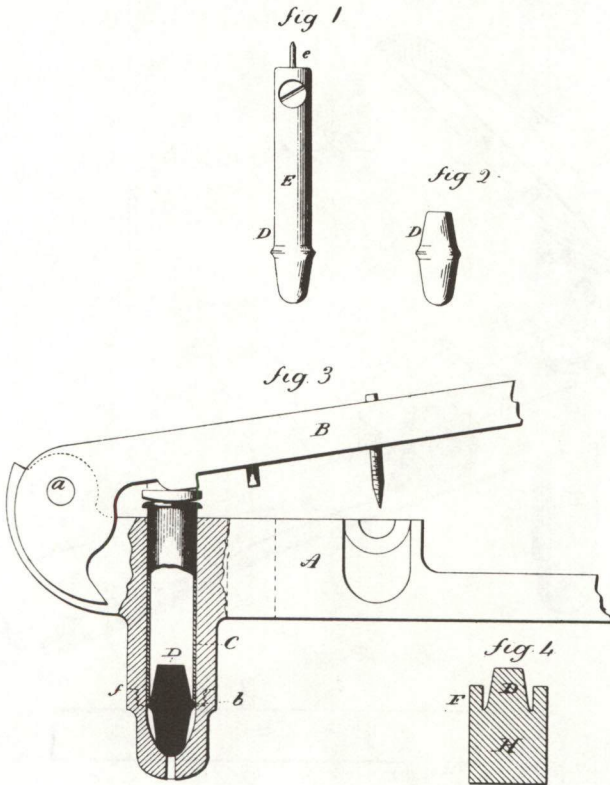

Witnesses  
J. A. Shumway  
J. C. Parle

John H. Barlow  
Inventor  
By atty.  
Wm. C. Cook



(No Model.)

W. W. WETMORE.

CARTRIDGE RELOADING IMPLEMENT

No. 376,930.

Patented Jan. 24, 1888.

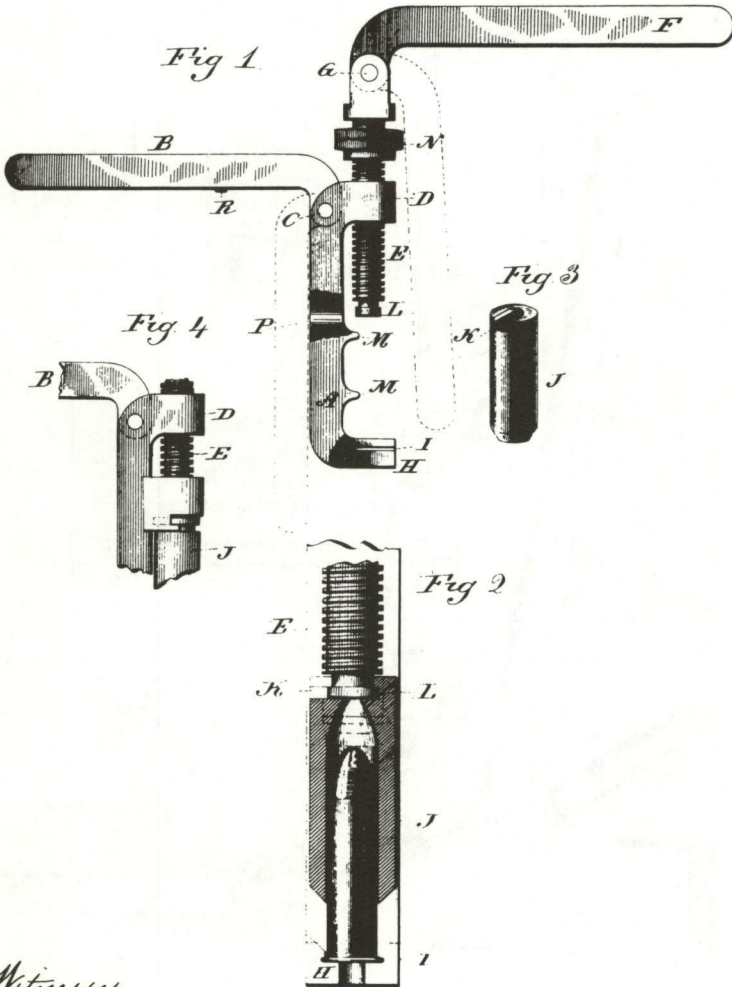

Witnesses,  
*J. K. Shumway.*  
*Fred C. Carey*

*Wm. W. Wetmore.*  
By atty *Chas. C. Emili.*  
Inventor.

(No Model.)

C. H. GRIFFITH.  
CARTRIDGE RELOADING IMPLEMENT.

No. 448,228.

Patented Mar. 17, 1891.

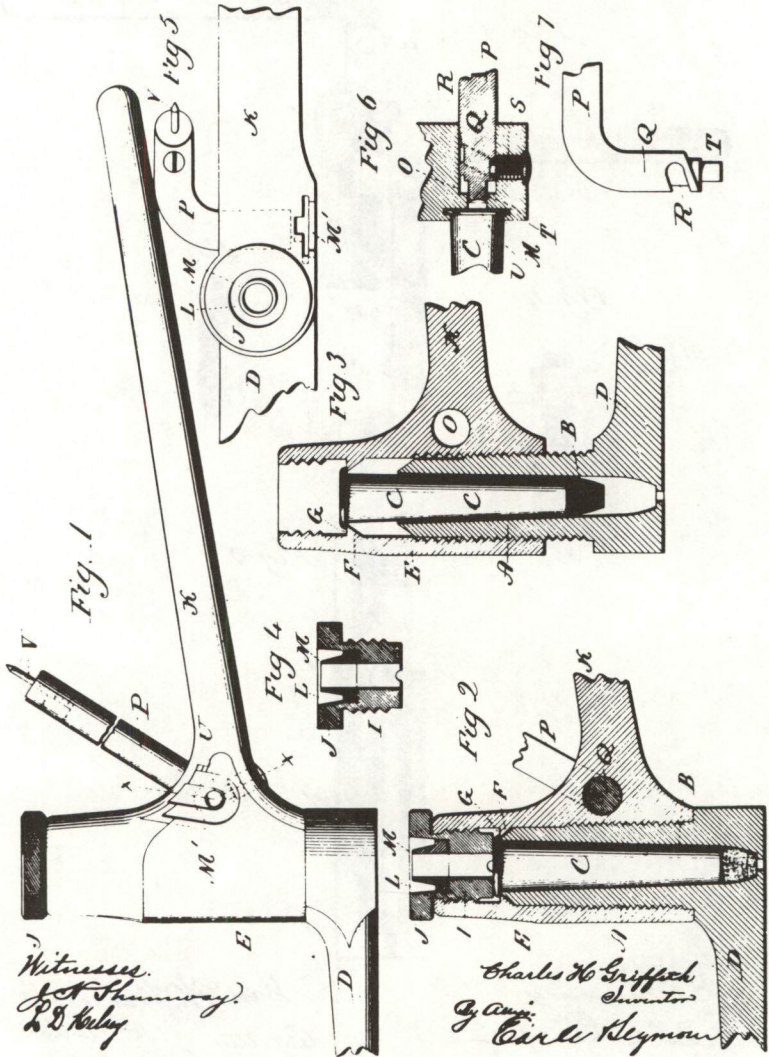

Witnesses.  
J. A. Shannon  
L. D. Kelley

Charles H. Griffith  
Inventor  
By Amos  
Carle Seymour

G. W. HADLEY.  
Cap Extractor.

No. 201,774.

Patented March 26, 1878.

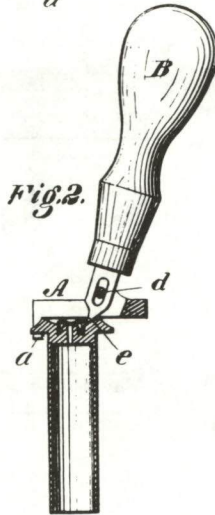
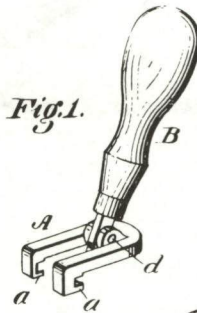

*Witnesses:*

*Donw S. Twitchell.*  
*S. M. Madden.*

*Inventor:*

*Geo. W. Hadley*  
*By his atty.*  
*Dodger*

(No Model.)

G. W. HADLEY.

IMPLEMENT FOR CAPPING AND UNCAPPING CARTRIDGE SHELLS.

No. 310,583.

Patented Jan. 13, 1885.

Fig. 1.

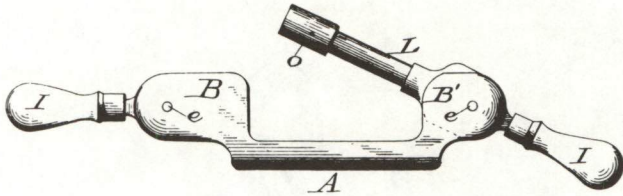

Fig. 2.

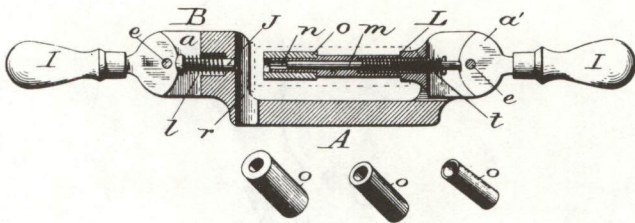
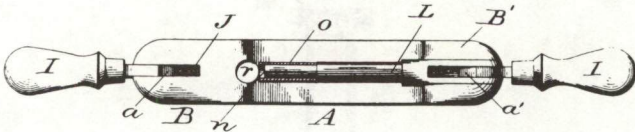

Fig. 3.



Witnesses:

Jas. F. DeKamfel.  
Walter S. Dodge

Inventor:

Geo. W. Hadley  
by Dodgerson  
Atty.

(No Model.)

J. M. & M. S. BROWNING.  
CARTRIDGE LOADING IMPLEMENT.

No. 247,881.

Patented Oct. 4, 1881.

Fig. 1

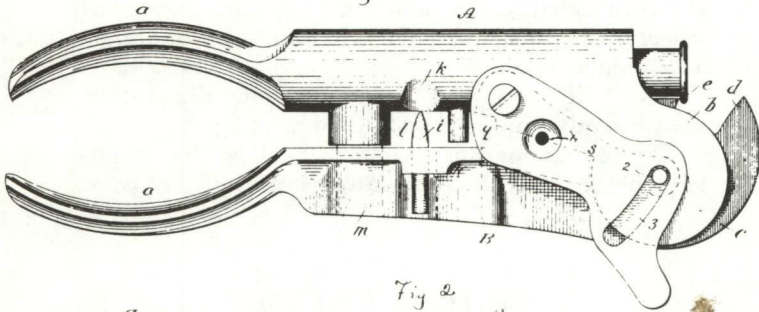

Fig. 2

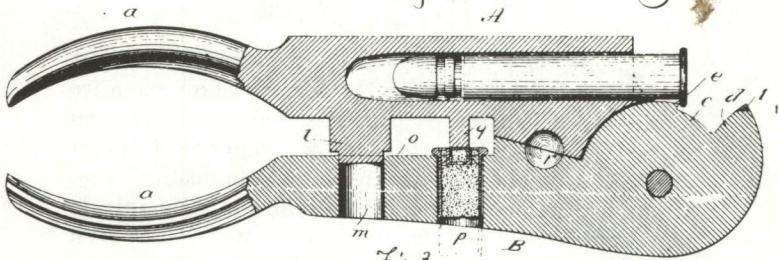

Fig. 3

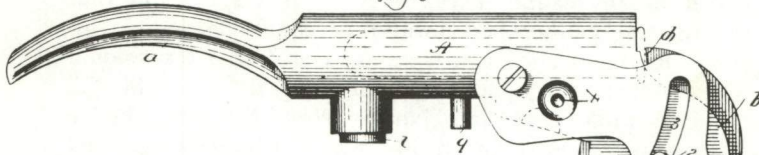
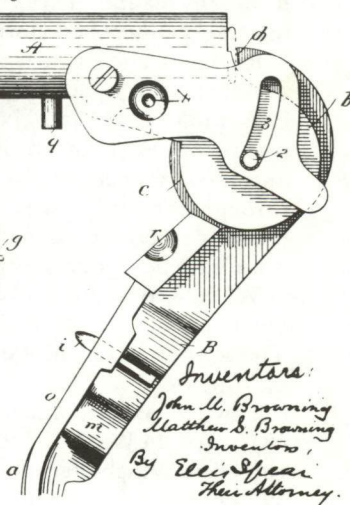

Fig. 4



Witnesses:  
Arthur Wagner  
Frank Middleton



Inventors:  
John M. Browning  
Matthew S. Browning  
Inventors  
By Ellis Spear  
Their Attorney.

## ADDENDUM

When it came time for reprinting of *Early Loading Tools and Bullet Molds*, the author used various means to solicit additional material and corrections to include in the new printing. Some information was forthcoming and is included in this addendum. We are particularly indebted to James Zupan and Bob Borchardt for both information and photos.

Also included are some patent illustrations inadvertently omitted from the first printing.

The format for this section will follow the chapter sequence in the book proper. Space is provided for notes.

## WINCHESTER

Raymond Bell, Jr., who prepared the excellent chart on p. 17 and 18 and has given generously of his extensive knowledge of Winchester products, reports an error on page 8. The tool illustrated in A was patented October 20, 1874. September 30 was the patent application date. Although the first tool was advertised as available in many calibers, neither Mr. Bell nor the author have seen it in any caliber except .44-40. Bell speculates that multiple calibers began with the second style.

Ray Bell also reports seeing one of the transitional tools (F), with mold, and both stamped "N. W. M. P." indicating Canadian North West Mounted Police ownership. We know the Mounted Police special ordered and used Winchester 1876 carbines from the late 1870's through the turn of the century. This is the only such marking reported to date. Each item also bore what must have been an inventory number.

W. O. Kroz reports a Winchester hollow point mold in .45 Express with the hollow point attachment missing. The author has a similar mold in .40-110 Express also lacking the pin.

Lewis Yearout points out that the brass bullet molds (B) bear ".44 W. C. F." stamping identical to that on the early cast Winchester tools thus confirming its identity as Winchester.

James Zupan observes that Winchester molds are found with the different sizes of block.

## REMINGTON

The Remington shell reducer and expander in (C) has been observed by James Zupan to come in green paint finish as well as red and nickel plate. This fact points up the need to refrain from removing what may at first be suspected to be a non-original paint finish and thus damage the originality of the item.

An unusual Remington mold in the Jack Appel collection has a double cut off plate like those made by Harry Pope whereby the cavity runs clear through the block with the bottom cut off at the bullet's base. The mold is in .32-40 Remington caliber and stamped "Remington Arms Co." This would date it after 1887. Prior to that year it was "E. Remington Sons."

## MARLIN

Lewis Yearout confirms the fact of no duplicate numbers on the Marlin combination tools as shown in (D) and extends the serial number range down to 403.

He also points out that the Browning tool (F) infringed on Winchester's V. A. King patent of September 14, 1880 but that Winchester granted Browning permission to market the last few of them.

## SHARPS

Bob Borchardt has a double rarity; a Sharps *grooved* bullet mold with a *factory original hollow pointing attachment*. The attachment is similar to the Sharps wad seater.

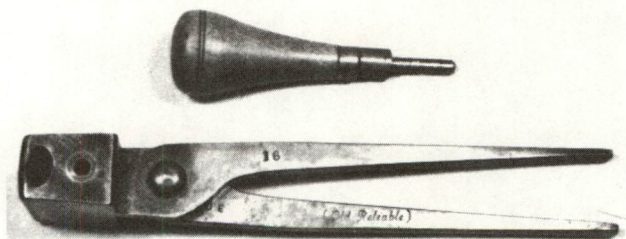
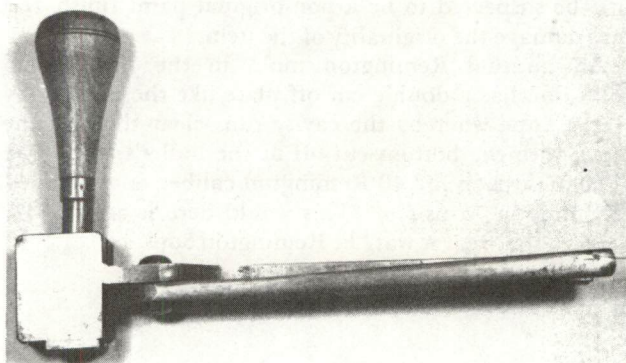

Another double rarity Sharps mold in the Borchardt collection is for a grooved bullet and has a sprue cutoff plate. The usual Sharps sprue nippers are omitted.

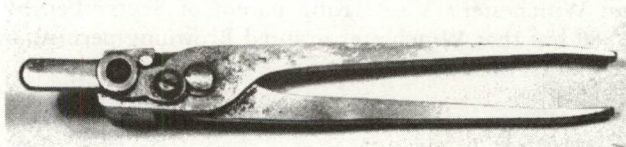

Still another Sharps rarity, a two cavity early (but not percussion) mold was seen by James Zupan at a recent gun show.



## MISCELLANEOUS TOOLS

In the first printing, we showed a Whitney bullet mold (I). James Zupan has a similar mold and black Japanned re-decapper shown here. The mold caliber is ".44-77 gr."

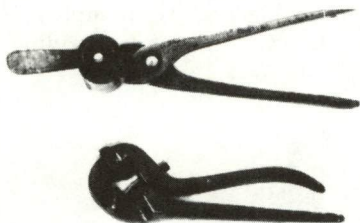

His set of Frankford Arsenal tools is illustrated. It is .50-70 government caliber and includes three-piece loading and crimping die, decapper, sizing die, and screw capper (?).

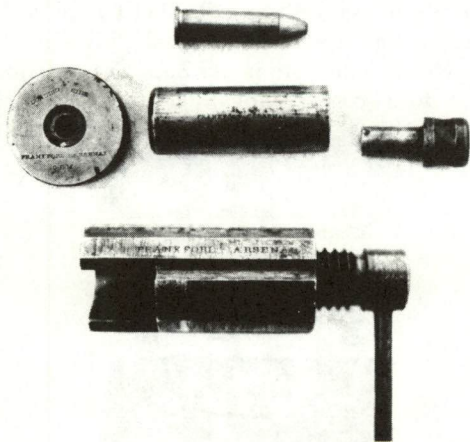

From the Bob Borchardt collection comes this bullet mold, paper patch template, and patch knife. It is stamped "Remington", "No. 5561" and "40 cal". The template also bears the "40 cal" marking. Although stamped "Remington" the mold is probably not a product of that company. The four digit number suggests possible Bridgeport Gun Implement Company manufacture. B. G. I. made loading tools for Remington.

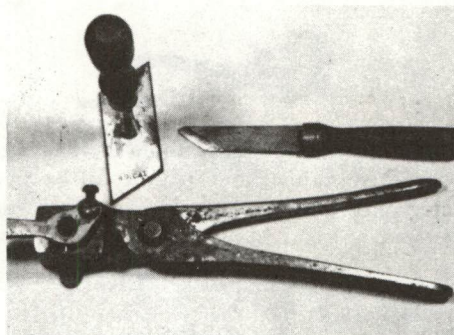

## IDEAL

An Ideal Perfection mold in the collection of W. O. Kroz does not have an adjustment screw to regulate the length of the bullet. Instead, there are several plugs of different lengths available. The plug is held in place by a side screw. Perhaps it is like the Rabbeth mold in (L).

The little gadget called the Ideal Shell Indenter is not common. Here is one from James Zupan's collection with shell holder for two different calibers and its factory box.

